

Supervised Feed Forward Neural Networks for Smart Chessboard Based on FPGA

Yaser M. Abid, Alaa Hamza Omaran and Ruqaiya Jwad
Business Informatics College,
University of Information Technology and Communication, Baghdad, Iraq

Abstract: Chess game is considered as the one of the most complex game due to its rules and conditions. It is rather difficult to the beginners to learn all its rules and conditions of movements for each piece in the chess game to be able from playing the game. Today, technologies used to help a human for solving their problems in this study, a smart chessboard designed to guide the players with the next available positions for each piece on the chessboard according to the current position. The proposed smart chessboard trained using neural network with feed forward neural networks algorithms which determine the movements for each piece on the chessboard squares.

Key words: Neural network, smart chessboard, artificial algorithms, chess game, intelligent controller, feed forward algorithm

INTRODUCTION

Chess game is the one of the complex games according to their conditions and positions which is hard for the beginners to remember them quickly. This game depends on the development of enormous mental abilities possessed by humans and it is widely used in the world due to its beautiful features. The beginners feel with difficulty in learning all its conditions and positions that should be used for each piece in order to move them on the chessboard as well as this will take a lot of time from the user to be trained on the movement for each piece according to the multiple number of pieces and the different positions for each one (Awodele and Jegede, 2009). There are a number of systems are designed for this propose such as mobile application and computer's programs, whatever, it is rarely of using smart and practical chessboard. Generally, the artificial intelligence proved its quality in many practical and theoretical researches which has been applied in many different fields (Antsaklis, 1990; Averbakh and Averbakh, 1996). Therefore, efforts have been made to use the artificial intelligence in designing smart chessboard; Chhangani (2015) presents a system consists of two chessboards that each player has one, Arduino, maga, reed switches and Bluetooth to connect between the chessboards. However, this system focuses on the entertainment rather than the learning of the rules of the chess game (Kaur *et al.*, 2010). Presents a trying in designing an Artificially Intelligent Microcontroller based Chess

Opponent (MAICO) that compete the agent, it uses microcontroller, camera and several algorithms. However, this system focuses on designing an intelligent chessboard compete the user rather than trying to guide the user for playing. Su *et al.* (2009) presents a mobile robot which depends on the Chinese rules for chess game to move the next position according to the attribute of the chess piece. The mobile robots received the commands from the supervised computer, however, this system focuses on designing mobile robot rather than learning the rules to the user start playing. Al-Saedi and Mohammed (2015) presents a system that controls robotic manipulator arm it tracks the opponent movement through building smart chessboard. The necessary information between the system parts are exchanged through a Network Control System (NCS), however, similar to the previous system which don't present a smart system that guide the user to learn the rules of moving the chess piece according to its attribute. Omran *et al.* present theoretical part of chess board that depend on the LDR in order to produces next steps and the way of training of networks need too much neurons in input and hidden layers because of the algorithm used in training.

This study proposed a smart chessboard which can guides usersto exactly know the next position for each piece, through a simple pressing on the piece all the available positions for this piece will be glowing. It is worthy to say that the proposed system uses simple hardware with low cost unlike the previous systems which have high cost according to its hardware.

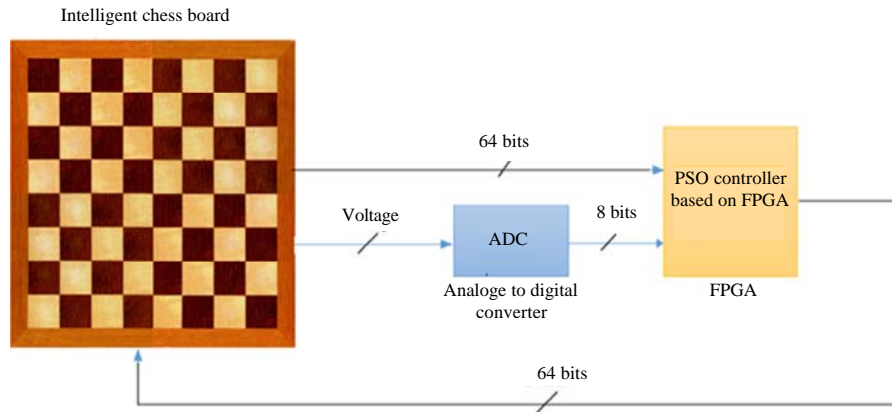

Fig. 1: The proposed intelligent chessboard

MATERIALS AND METHODS

Proposed system: The proposed of smart chessboard used to simplify the learning of rules of chess game it consists of smart board where simple hardware components are used in the designing of this board, seven intelligent controllers and analog to digital convertor as shown in Fig. 1. The intelligent controllers are used to send signals to show the available positions for each piece on the smart chessboard according to its current position. Each piece has its own voltage levels which are limited by series resistance that are connected to a LDR sensor. The LDR sensor is used to distinguish between the pieces on the smart chessboard. Note that, the smart chessboard contains 64 push buttons, 64 laser diodes and each piece has its own LDR sensor with limited levels of voltage. The current position of any piece can be determined through a simple pressing on that piece, the simple pressing on a specific piece will results in pressing a push button which in turns enable the laser diode to send a signal to the LDR sensor of the pressed piece. Then, the output voltage level of the LDR sensor will determine the type of piece which used by the neural network to show all the available position for this piece according to the current position.

The simulation results of training smart chessboard: As knowing, the chess game consists of 32 pieces which are divided equally into two teams black and white. Each team has its own 16 pieces which are classified into 6 types: Pawns, Rooks, Bishop, Knights, King and Queen. In more details for each team there are eight pieces of Pawns, two pieces of Rooks, two pieces of Bishops, two pieces of Knights, one piece of King and one pieces of

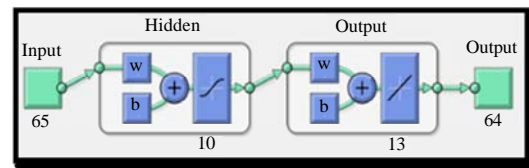

Fig. 2: Feed forward networks of King pieces

Queens. These 6 types have their own ways in moving on the chessboard which means there are specific rules for each type in the moving which are different from others.

In order to determine the correct movement for each type a neural networks are used for each piece and trained by using feed forward algorithm. It is worthy to say that, the rules of moving of the same type at the two teams are same which means that the movement of the King for example at the black team is the same movement of the King at the white team and the same matter for the other types. The rules of movements for each type are explained in details in the next subsections.

King: As knowing, the most important piece in the chess game is the King piece because the dying of the King leads to lose the game. It moves one square in any direction thus, the feed forward networks trained for all possible squares which can be taken by the King piece on the chessboard. The trial and error method is used in choosing the hidden layers as well as the activation function which used in the network and the number of neurons in each network that used in the proposed system. Figure 2 shows the network which used in the proposed system and Fig. 3 shows the results of the training of feed forward networks for the King pieces.

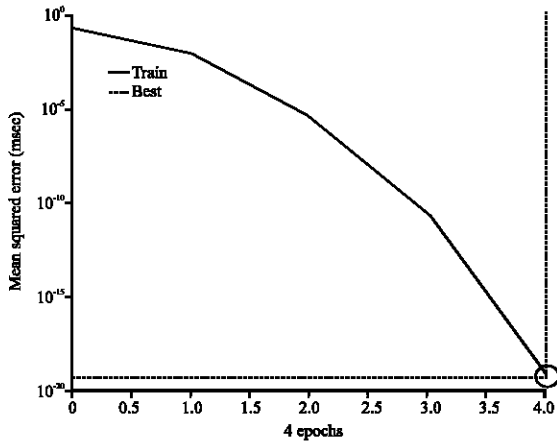

Fig. 3: The simulation results for training of King pieces; Best training performance is $3.9134e-20$ at epoch 4

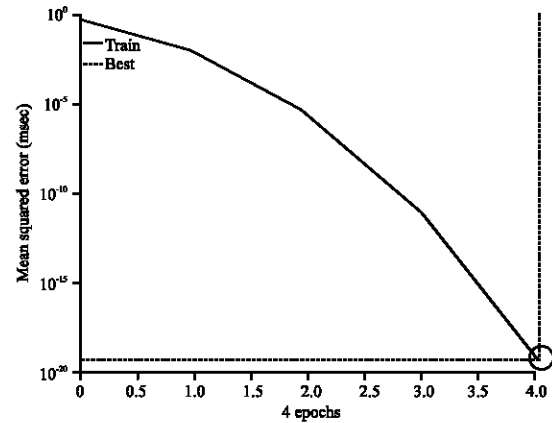

Fig. 5: The simulation result for training of Knight pieces; Best training performance is $2.9887e-21$ at epoch 4

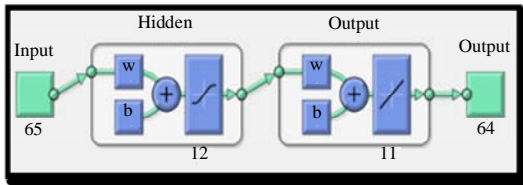

Fig. 4: Feed forward networks of Knight pieces

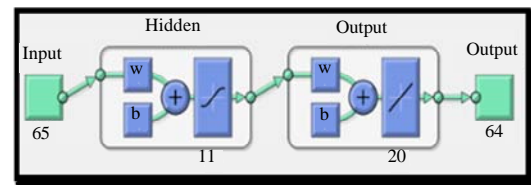

Fig. 6: Feed forward networks of Bishop pieces

Knights: The knight's pieces are considered as the powerful pieces of the chess game. Its movement are similar to the shape of letter L in more details, it moves either two squares vertically and one square horizontally or in contrast, moves one square vertically and two square horizontally. Note that, the knight pieces are only the pieces which can jump over the other pieces. It uses special matrix in training with feed forward algorithm which is different than the other pieces due to its movements. Figure 4 shows the network which used in the proposed system for knight pieces and Fig. 5 shows the results of the training of feed forward networks for the knight pieces. Furthermore, the trial and error method is used in choosing the hidden layers as well as the activation function which used in the network and the number of neurons in each network that used in the proposed system.

Bishops: The Bishops pieces moves diagonally on the chessboard, they are unlike knight pieces cannot jump over any piece on the chessboard. It also uses its own matrix for training with feed forward algorithm which is different than other according to its movement on the chessboard. The trial and error method is used in choosing the hidden layers as well as the activation function which used in the network and the number of neurons in each network that used in the proposed

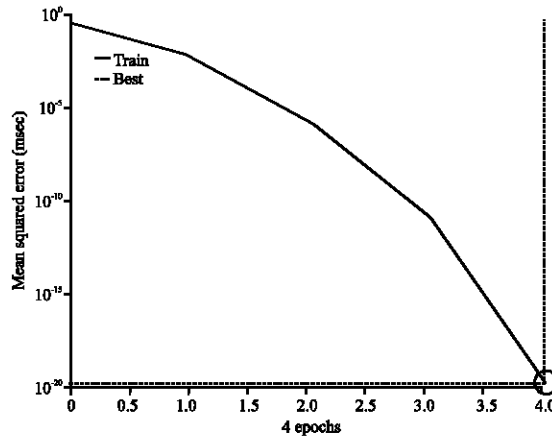

Fig. 7: The simulation results for training of Bishop pieces; Best training performance is $1.539e-19$ at epoch 4

system, Fig. 6 shows the network which used in the proposed system for Bishop pieces and Fig. 7 shows the results of the training of feed forward networks for the Bishop pieces.

RESULTS AND DISCUSSION

Roos: The rook pieces in chess game moves diagonally and horizontally over the chessboard and like the Bishop

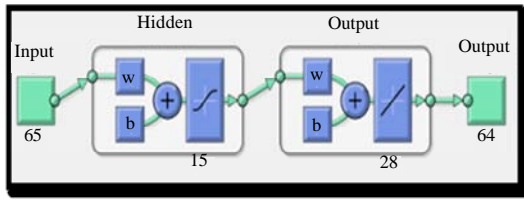

Fig. 8: Feed forward networks of Rook pieces

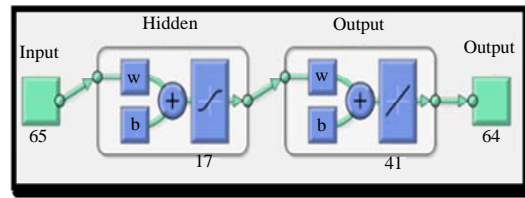

Fig. 10: Feed forward networks for Queen pieces

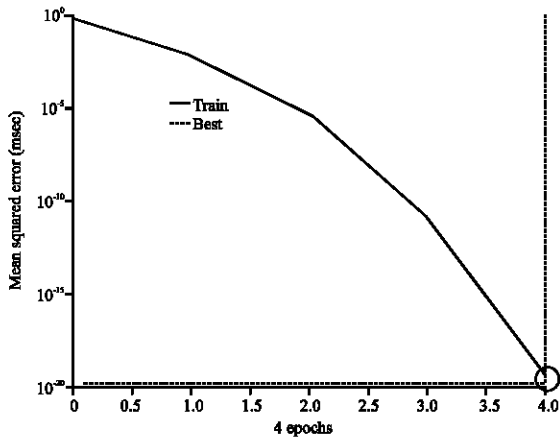

Fig. 9: The simulation results for training of Rook pieces; Best training performance is 2.3834e-20 at epoch 4

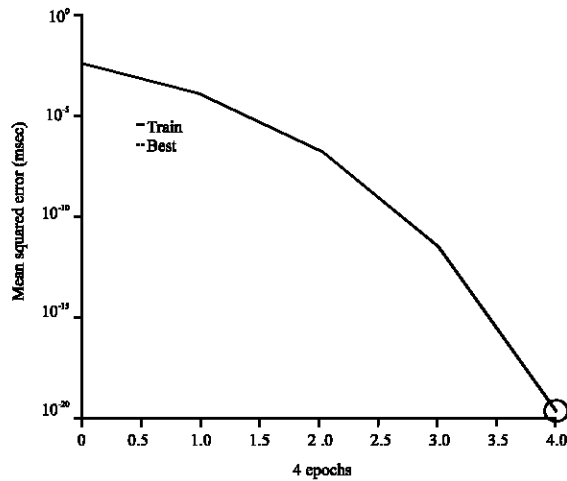

Fig. 11: The simulation results for the training of Queen pieces; Best training performance is 2.4632e-20 at epoch 4

cannot jump over any other piece on the chessboard and like the other pieces has its own special matrix for training with the feed forward algorithm which is different than the other pieces due to its movement on the chessboard. Also, the trial and error method is used in choosing the hidden layers as well as the activation function which is used in the network and the number of neurons in each network that is used in the proposed system. Figure 8 shows the networks which are used within the rook pieces and trained for all the possible squares on the chessboard for the rook movements. Figure 9 shows the results of the training of feed forward networks for the rook pieces.

Queens: The Queen pieces are the most powerful piece on the chessboard in the chess game, it can move in any direction in at any square (diagonally, horizontally and vertically). It mixes the power of the rook and the power of bishop pieces and also it cannot jump over any piece on the chessboard. These pieces are like the other pieces and use their own matrix for training with the feed forward algorithm which is different than others according to its movement on the chessboard. Figure 10 shows the networks which are used within the Queen

pieces. Figure 11 shows the results of the training of feed forward networks for the Queen pieces. Also, the trial and error method is used in choosing the hidden layers as well as the activation function which is used in the network and the number of neurons in each network that is used in the proposed system.

All the trained networks for each piece are converted into Simulink for testing the results of all pieces on the smart chessboard as shown in Fig. 12 and the chessboard is tested with different states at different times.

The neural network with the feed forward algorithm is used for the training of the smart chessboard. There are seven intelligent controllers used for each type of piece (Rooks, Knights, Bishops, Kings, Queens, White pawns and black pawns), respectively. The proposed system has different ranges of voltage levels for pawn pieces because of the opposite way of movement for the black and white pawns. When the user needs to know the next position of any piece on the chessboard, a simple press on that piece makes a push button pressed and the laser diode sends a signal to the LDR sensor which is built in the piece in order to recognize the piece and to determine its current position

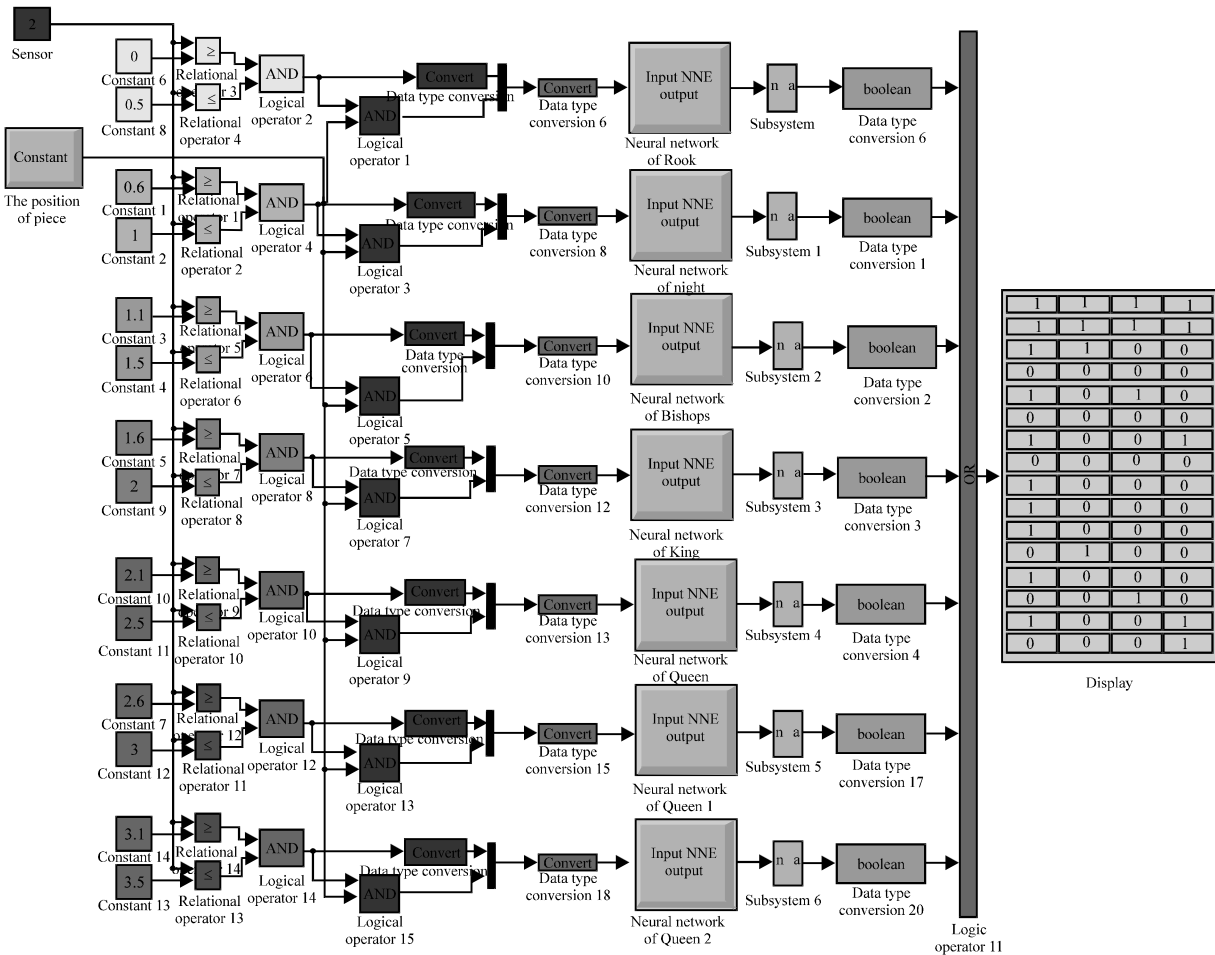

Fig. 12: The smart chessboard trained by feed forward for all the pieces of chess game

on the chessboard. The smart chessboard interacts with this input which results in turn the LED by change its state to ON, then next available positions of the pressed piece are displayed on the smart chessboard.

CONCLUSION

In this study smart chessboard system designed, seven intelligent controllers are used one for each type of pieces (King, Queen, Rook, White pawn, Black pawn, Knight and Bishop), respectively. The proposed system trained using neural network with feed forward neural network algorithm for each piece on the chessboard to determine all the available positions which can be taken at the next movement for each piece on the chessboard. It will guide the players with important rules and conditions of the chess game. The intelligent controllers tested using MATLAB which results in producing the exact positions for different states.

REFERENCES

Al-Saedi, F.A.T. and A.H. Mohammed, 2015. Design and implementation of chess-playing robotic system. Intl. J. Sci. Eng. Comput. Technol., 5: 90-98.

Antsaklis, P.J., 1990. Neural networks for control systems. IEEE. Trans. Neural Netw., 1: 242-244.

Averbakh, I. and Y. Averbakh, 1996. Chess Middlegames: Essential Knowledge. Cadogan Chess, London, England, ISBN:9781857441253, Pages: 112.

Awodele, O. and O. Jegede, 2009. Neural networks and its application in engineering. Proceedings of the 2009 Conference on Informing Science and IT Education (InSITE'09), June 12-15, 2009, Informing Science Institute, Macon, USA., pp: 1-13.

Chhangani, M.A., 2015. Arduino based wireless powered chess. Intl. J. Innovative Res. Comput. Commun. Eng., 3: 3187-3194.

- Kaur, G., A.K. Yadav and V. Anand, 2010. Design and implementation of artificially intelligent microcontroller based chess opponent. Proceedings of the 2010 World Congress on Engineering (WCE'10) Vol. 1, June 30-July 2, 2010, IAENG, London, UK., ISBN:978-988-17012-9-9, pp: 1-5.
- Su, K.L., S.V. Shiau, J.H. Guo and C.W. Shiau, 2009. Mobile robot based online Chinese chess game. Proceedings of the 4th International Conference on Innovative Computing, Information and Control (ICICIC'09), December 7-9, 2009, IEEE, Kaohsiung, Taiwan, ISBN:978-1-4244-5543-0, pp: 528-531.