

Modified PI Controller to Improve the Performance Characteristics of the PMSM

Hamdy Mohamed Soliman, S.M.EL. Hakim

Abstract— Classical vector control for the permanent magnet synchronous motor (PMSM) is depending upon the mathematical model and hence any problem in the machine parameters or AC drives will deteriorate the performance of the drive system over all. So this paper suggested using four PI current controllers to improve the performance characteristics of the drive system. Three of them is used in the bang-bang control of inverter by rate of one for each phase and the other PI current controller is used to improving the q - axis current component at sudden applies or removes the load. this reflects the performance over all and improve it. The MATLAB Simulink is used to simulating the drive system. The proposed model of the vector control is compared to classical vector control to show the improvement occurs in the performance characteristics of the system with proposal method. The proposed cases are simulated through the MATLAB program and are operated in the laboratory. The laboratory results agreed with the simulating results that have been obtained.

Index Terms— Bang-bang inverter control, PI control, PMSM, vector control.

I. INTRODUCTION

Permanent magnet synchronous motors (PMSMs) are widely used in the industrial applications due to have high torque to current ratio, high torque to inertia, high efficiency, quick acceleration and deceleration and high long life. The performance of these motors in drive systems depend up on the motor control and method of control in power converter. From the most important methods to control the power converter are current and voltage controls. The current control is preferable. This is because it is simple. The quality control of this method depends upon the quality of the waveform is generated by current controlled of converter [1-2]. To get good power waveform this depends upon the following factors: -

1. Switching frequency of the PWM which has low harmonics if it is high but it has drawback such as: high losses.
2. Modulation method which control the magnitude of the output waveform but it has drawback such as: high order of voltage harmonics and ripple current.
3. Types of current waveform. This is because each motor required own current waveform such as: induction motor and PMSM required sine wave but brushless DC motor required quasi square wave form.

The method of motor control is very important in the drive system. This is because the operation of the PMSM under

effect of scalar control is suffered from complicated coupling nonlinear dynamic performance. This problem can be solved by vector control (VC). The vector control is used to making the PMSM emulates separately excited DC motor to improve the dynamic performance. In this method of control, the stator current can be decoupled into flux and torque current components. They can be controlled separately. In four quadrant with keeping magnetic circuit linear and applying the principles operation of the VC, the linear relation can be described the motor torque.

With using the VC, the PMSM still suffered from ripples and noise in the motor torque, motor current and harmonics in both motor and inverter. These problems affect the motor performance. These problems shape difficult in getting robust control. They lead to problems in torque and oscillation in the speed as the secondary problem comes from torque problem.

There are many methods of control tried to get rid these problem by design robust current control of the drive system, programs to cancelation the harmonics but these methods require full knowledge about the machine parameters. These methods become undesirable if the operating point changes [3-6]. The current control scheme with an adaptive internal model is proposed in many researches as [7]. Passive filter is used to reducing the torque ripples in [8] but higher circulating current arises between filter and inverter. Active filter is used to reducing the torque ripples but this method is higher cost [9]. linear and non-linear current controllers. Linear controller includes PI controller, state feedback controller and predictive current controller. Nonlinear controller includes bang-bang controllers (Hysteresis control, ramp type control and delta modulator) and predictive controllers with online-optimization [10]. Proportional integrator controller (PI), it is the most common controllers used in a wide range in the industrial applications. The popularity of PI control can be attributed to its simplicity. The integral controller has drawback such as saturation. This phenomenon can be avoided by introducing a limiter to the integral part of the controller before adding its output to the output of the proportional controller. The output of the PI is used as the input of controlled voltage source inverter which is fed to the motor for controlling its speed [11]. Also PWM current-controlled voltage source inverters are widely used in high performance AC drives for quick response and accurate control. It has substantial advantage in eliminating stator dynamics in high performance AC drive systems under field oriented control. Here PWM hysteresis current control is discussed. In these methods of current control, the load currents are measured and compared with the reference currents. The error is used as the input to the PWM which is used to drive the switching frequency of inverter. In this

Revised Version Manuscript Received on July 05, 2016.

Hamdy Mohamed Soliman, The development and researcher director in Cairo Merto Gereater, Helwan, Egypt.

S. M.EL. Hakim, Department of Electrical Power and Machines Engineering, Cairo University/ Engineering College, Giza, Egypt.

Modified PI Controller to Improve the Performance Characteristics of the PMSM

paper, four PI current controller are used. The first three PI current controllers are used to adaptive hysteresis current controller and the other is used to attenuate the torque current component in the vector orientation block in case of sudden applied or removal the load. This can be done by design PI current controller in each phase of the inner loop of current controlled inverter and design PI for the torque current component. It is approximately vanishing the torque ripple and improvement the total harmonic distortion at any operating conditions and absorbing the effect of sudden applying or removal the load. This paper concluded that; I- Introduction, II- Mathematical model of PMSM, III- The drive system, IV- PI controller, V- Simulation result, VI- Hardware configuration, VII- Laboratory result and VIII- Conclusions

II. MATHEMATICAL MODEL OF PMSM

The mathematical model of a PMSM is similar to that of wound rotor synchronous motor. The rotor winding of synchronous motor is replaced with high resistivity permanent magnet material, hence, induced current in the rotor are negligible. The rotor types of PMSM are shown in Fig.1. The permanent magnets on the rotor are shaped in such a way as to produce sinusoidal back EMF in stator windings.

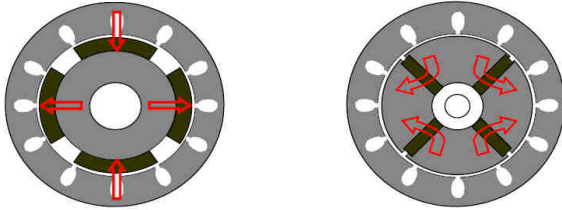

(a) PM surface mounted (b) PM surface interior (buried)

Fig 1. The types of the rotor in PMSM

The following equations represent the mathematical model of the PMSM

$$v_d = r_s i_d + L_d \frac{d(i_d)}{dt} - \omega_r L_q i_q \quad (1)$$

$$v_q = r_s i_q + L_q \frac{d(i_q)}{dt} + \omega_r L_d i_d + \omega_r \psi_m \quad (2)$$

$$T_e = \frac{3}{4} P (\psi_m i_q) \quad (3)$$

$$T_e = T_L + \beta \omega_r + J \frac{2}{P} \frac{d\omega_r}{dt} \quad (4)$$

$$\theta_r = \frac{P}{2} \int \omega_m dt \quad (5)$$

Where v_d, v_q are the dq axes stator voltages, i_d, i_q are the dq axes stator currents, L_d, L_q are the dq stator axis inductance, r_s is a stator resistance, $\frac{d}{dt}$ is a derivative, T_e is an electrical torque, T_L is a load torque, J is a moment of inertia, β is a frictional viscous, ω_m is a mechanical speed, P is a number of poles and θ_r is an electrical position.

III. THE DRIVE SYSTEM

The block diagram of the PMSM drive system is given as Fig. 2, the drive system is composed of two blocks, the first is

for VC and the other is to regulate the current. Fig. 3 shows the details of the first block (VC block) in classical and in modified VC. In the classical and in modified methods a VC block contains only one PI controller (speed controller) at all operating conditions but in case of sudden applied or removal the load; another PI controller (torque controller) is used to absorb the effect of sudden applied or removal the load as shown in Fig. 4. In the classical current regulator block, the hysteresis current controller is used due to simple, fast dynamic response and insensitive to load parameters. The hysteresis current controller is shown in Fig. 5. In this method each phase consists of comparator and hysteresis band. The switching signals are generated due to error in the current. The error comes from comparing between the reference current and actual current. The main task of this method of control is to make the input current to close the reference current in each phase. The deviation of these currents (error current) represents the current distortion. The THD in the current can be calculated as

$$\text{The current distortion} = \frac{100}{I_{rms}} \sqrt{\frac{1}{T} \int (i_{act} - i_{ref})^2 dt} \% \quad (6)$$

In this method of control, the deviation of the current between two limits of the hysteresis band (upper and lower).

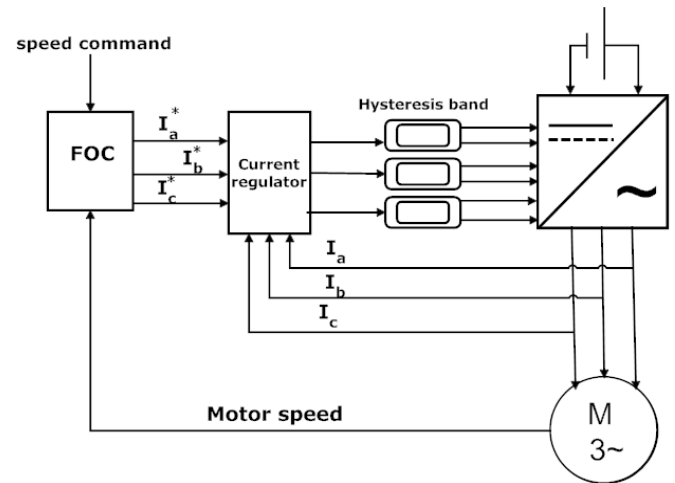

Fig. 2 Block diagram of PMSM drive system

In any phase, if the actual current becomes more than the upper limit of hysteresis band, the higher switch of the inverter arm becomes off and complementary switch on and the current starts to decay. In contrast if the actual current reaches lower limit of the band, the lower switch of the inverter arm is off, the upper switch is on and the current comes back into the hysteresis band. The band width of hysteresis calculates the switching frequency and current ripple. But in the current regulator modification block; the PI current controller is added after comparing the reference current and load current in each phase as shown in Fig.6.

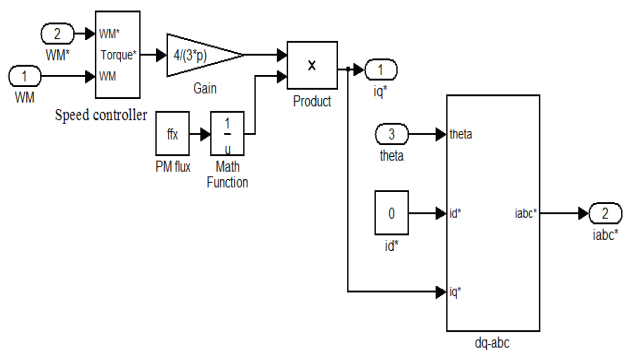

Fig. 3 VC details for classical and modified methods

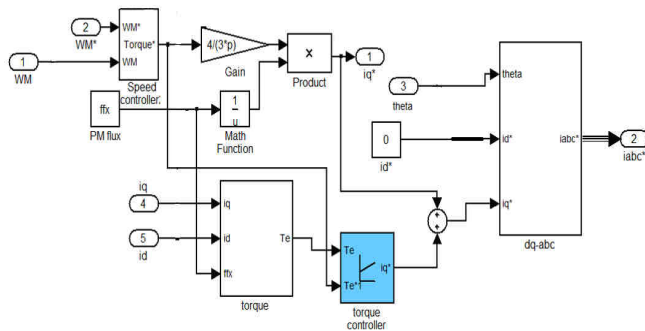

Fig. 4 VC details for classical and modified methods in case of sudden applied or removal the load

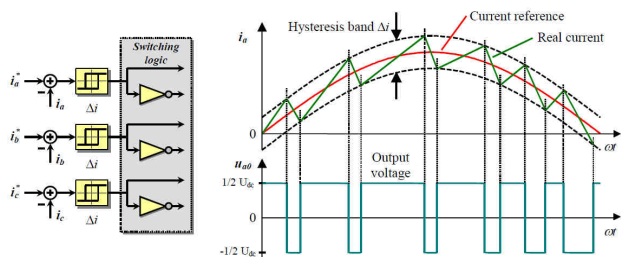

Fig. 5 Hysteresis PWM current control and switching logic

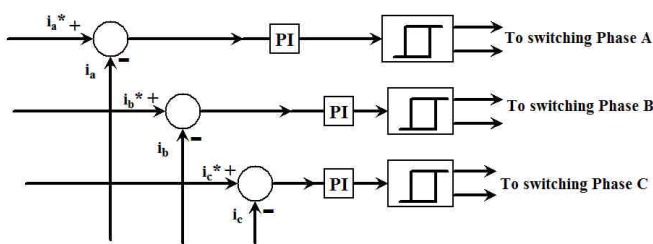

Fig. 6 Modified current regulated block.

IV. PI CONTROLLER

PI controller is the common element to control in the most of industrial applications. It has some advantages such as: fast response and zero steady state error. PI controller can be represented by first order transfer function as;

$$G_{PI}(s) = k_p + \frac{k_i}{s} \quad (7)$$

Where k_p is a proportional gain and k_i is an integral gain. The output of PI controller can be written as;

$$y(t) = k_p e(t) + k_i \int e(t) dt \quad (8)$$

Where $e(t)$ is an error between the desired values and measured values.

V. SIMULATION RESULTS

The simulation results of the proposal method here is compared to classical method to show the effectiveness of the modified method. table 1 shows the effect of modified method on the torque ripple and in the total harmonic distortion of the current (THD) this occurs through to cases. In the first case the motor start with approximately 50% of the full load torque at rated speed and in the second case, the motor start without load after certain time the 50% of the full load torque is applied and after certain time the load is removed. The motor data which used in simulation and in laboratory is in a table 2.

A. First case of study

In this case; the motor is approximately starting with 50% of the rated load. The motor torque and the load torque versus the time for classical method can be seen in Fig. 7 also the same torques for modified method can be seen in Fig. 8 where it is found that; the distortion in the motor torque with classical method is approximately vanish with the modified method.

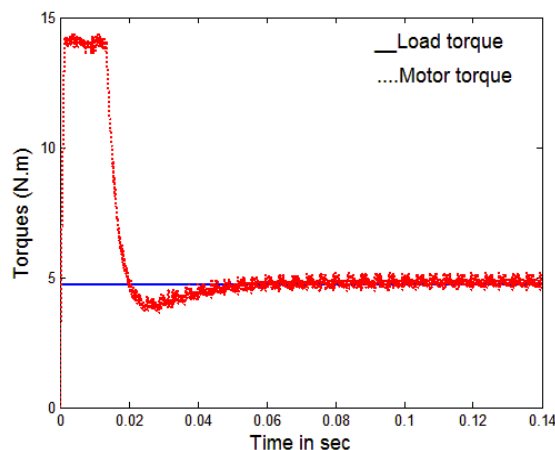

Fig.7 The torque with classical method

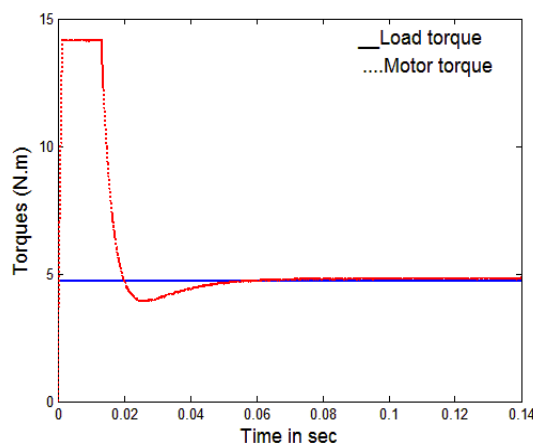

Fig.8 The torque with modified method

The motor speed for classical and modified method can be seen in Fig. 9 and in Fig. 10 respectively. Where from these Figs. It is found that;

The motor speed is approximately as the same for the two method of control.

Modified PI Controller to Improve the Performance Characteristics of the PMSM

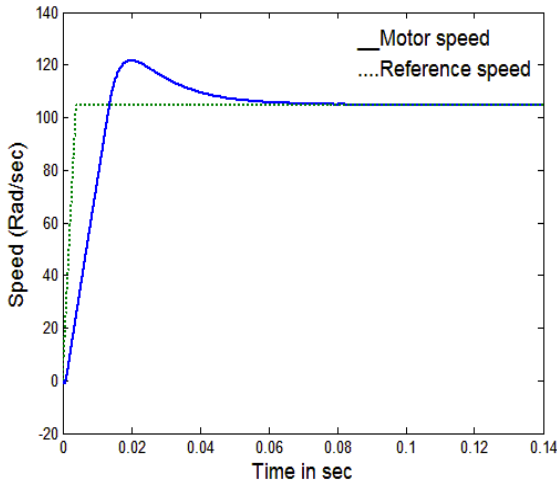

Fig.9 The motor speed with classical method

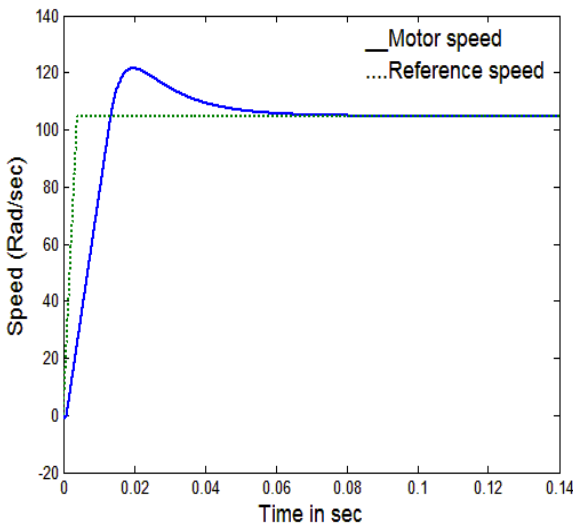

Fig.10 The motor speed with modified method

The motor current can be seen in Fig. 11 for classical method where Fig. 12 shows the motor current with modified method where it found that;

The motor current becomes smothering and total harmonic distortion is decreased with using the modified method if it is compared to conventional method.

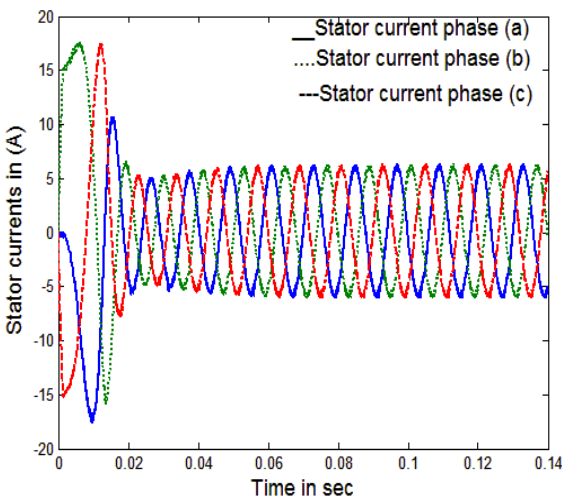

Fig.11 The motor current with classical method

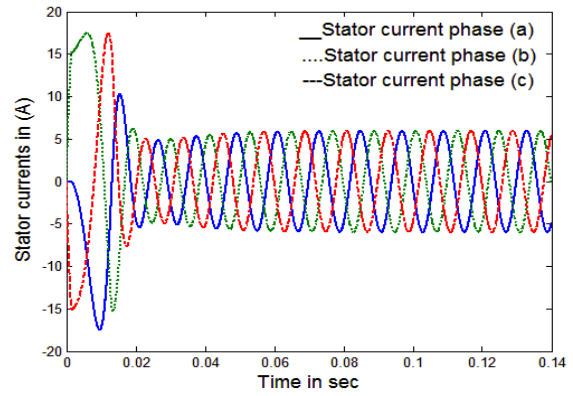

Fig.12 The motor current with modified method

B. Second case of study

In this case; the motor is running without load, at 0.1 sec. approximately 50% of the rated load is suddenly applied and continuous with this load up to 0.25 sec at this time, the load is suddenly removed. This occurs in the two methods of control under study to show the effectiveness of the modified on the performance characteristics of the motor comparing to the classical method where it is found that;

The motor torque for modified method is less in the ripples and in the distortion if it is compared to classical method as shown in Fig. 13 for classical method and in Fig. 14 for modified method.

The motor speed for classical and modified method can be seen in Fig. 15 and in Fig. 16 respectively. Where from these Figs. It is found that;

the same effect on the motor speed is approximately occurred for the two cases of study modified and classical methods.

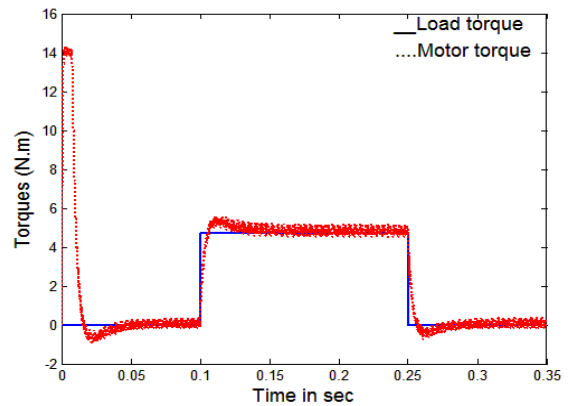

Fig.13 The torque with classical method

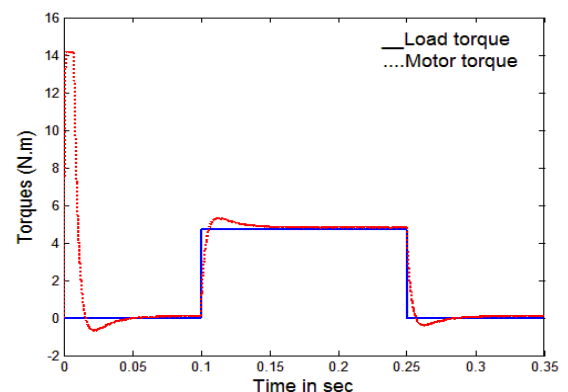

Fig.14 The torque with modified method

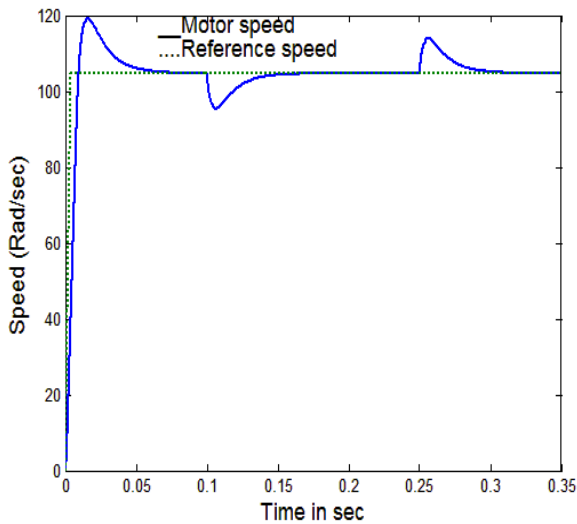

Fig.15 The motor speed with classical method

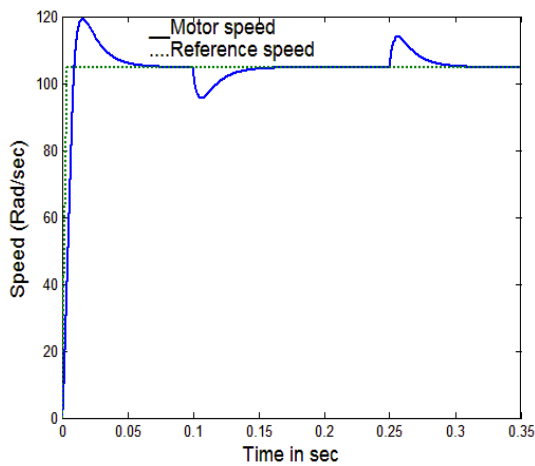

Fig.16 The motor speed with modified method

The motor current can be seen in Figs. 17 and 18 for classical and modified methods respectively where it found that;

With this improvement in the switching frequency due to use the PI current controller, the motor current becomes smoother and total harmonic distortion is decreased with using the modified method if it is compared to conventional method.

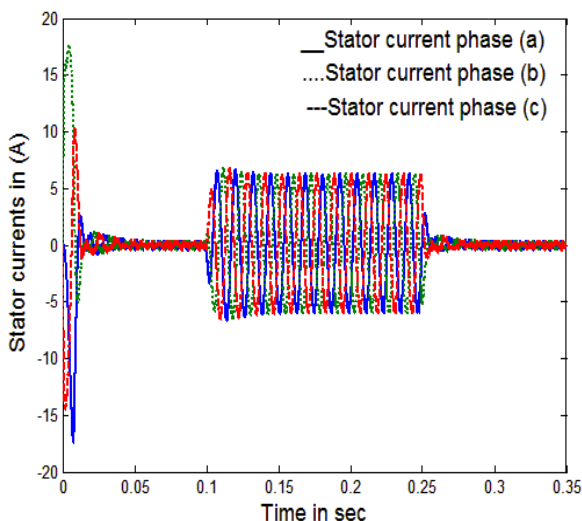

Fig.17 The motor current with classical method

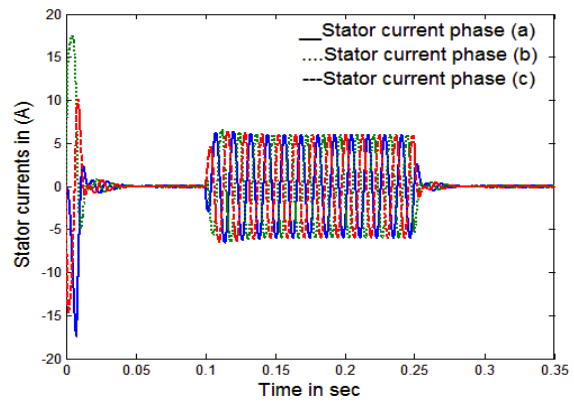

Fig.18 The motor current with modified method

From analysis of this it is found that; the motor speed is more effected by sudden applying or removal the load so the fourth PI controller is added in the VC block as shown in Fig. 4 for classical and modified method of controls to make damping for the over shooting of the motor speed in case of sudden applies load or removes load where it is found that;

The new PI (fourth PI) is damped the motor speed for sudden applying or removal the load for classical method control and for modified current control but the motor speed is highly distorted with classical method this because the three PI current controls doesn't exist with classical method which uses in the modified method to improve the THD in the current and torque ripples as shown in Figs. 19 and 20 for classical and modified method respectively.

VI. HARDWARE CONFIGURATION

Fig. 21 shows the loop diagram of hardware system configuration. The hardware components used in this are PMSM, PMSG, resistive load, inverter, TMS320F28335 DSP, three current sensors, encoder and signal conditioning circuits. They are shown in the photo of Fig. 22.

Special family of the DSP Texas Instruments (TI) can be used to controlling the different types of the motors. This family is called TI C2000 DSP. MATLAB software and Simulink deal with DSP. This occurs to transfer the data among DSP, MATLAB and personal computer to show the performance of the drive system and improve it. This occurs through special tools supported in MATLAB. These tools are real time workshop and embedded coder.

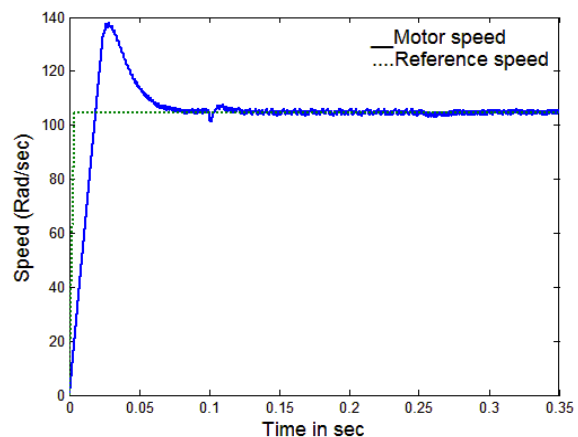

Fig.19 The motor speed with classical method when fourth PI was used

Modified PI Controller to Improve the Performance Characteristics of the PMSM

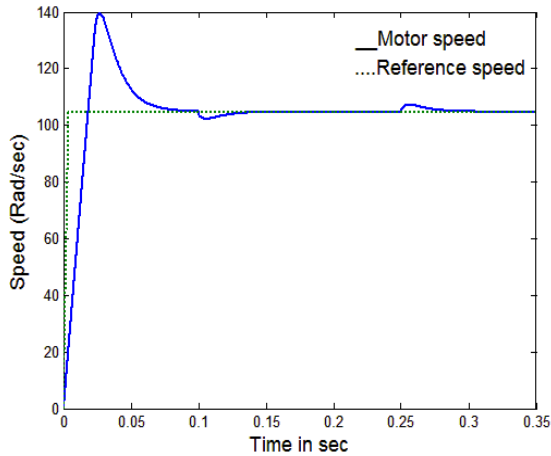

Fig.20 The motor speed with modified method when fourth PI was used

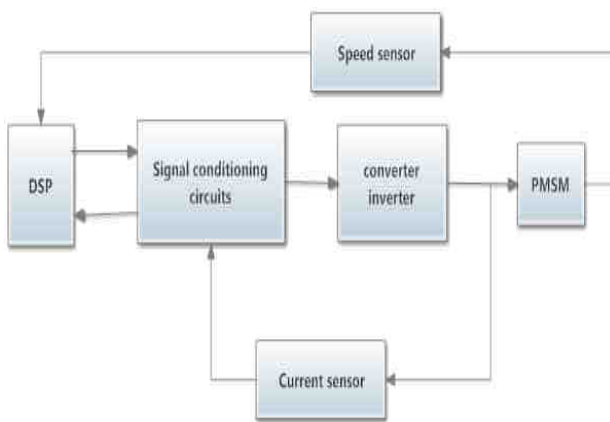

Fig. 21 Hardware diagram

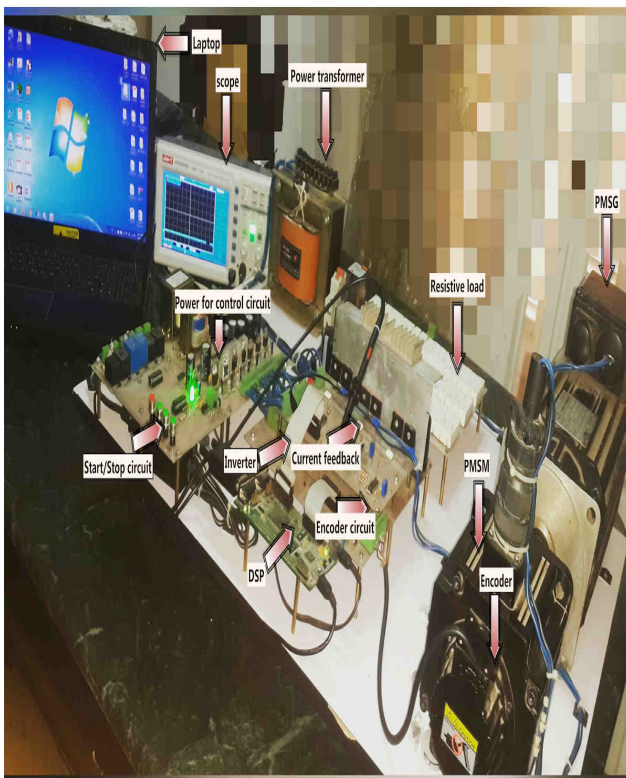

Fig. 22 A Photo Lab

After studying the proposed PMSM drive system and simulated the model in the MATLAB Simulink the following are needed in laboratory;

1. Rotor position reading, speed reading and direction.
2. Motor current reading.
3. PWM to drive the inverter.
4. Library to generate the reference currents and comparator.

So the TMS320F28335 DSP kit is chosen. This DSP is F28335 ezDSP. It is a standalone card. It has the requirements for this study. The operators can be communicated with the DSP via MATLAB Link for CCS.

VII. EXPERIMENTAL RESULTS

This shows the experimental results which operated in laboratory for hysteresis current controller. The two models (classical and modulating) are tested to show the effect of modified models on the performance of the motor compared to classical models. The same simulated cases are studied in the laboratory where it is found that;

A. First case of study

In this case; the motor is approximately starting with 50% of the rated load. The estimating motor torque by aid of the DSP for classical and modified model hysteresis current controllers can be seen in Fig. 23 and Fig. 24 respectively. From these Figs it is found that,

The distortion in the modified models are decreased if it is compared to classical model.

Motor speed responses for conventional and modified model hysteresis current controllers are shown Fig. 25 and Fig. 26. From these Figs it is found that,

The noise in the modified model is decreased if it compared to classical model this is because the ripples in the q-axis current of modified model is decreased due to improve the switching frequency.

Stator current of the motor for classical and second modified model hysteresis current controllers are shown Fig. 27 and Fig. 28. From these Figs it is found that,

The stator current is smoother in case of modified model if it compared to conventional model. The stator current becomes smoother due to use PI current controller to improve it.

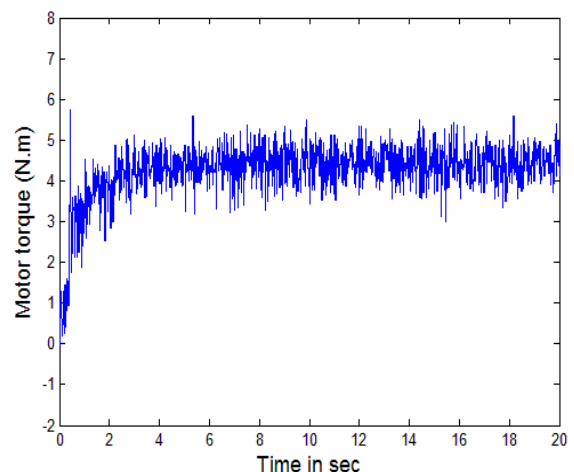

Fig.23 The estimated motor torque with classical method

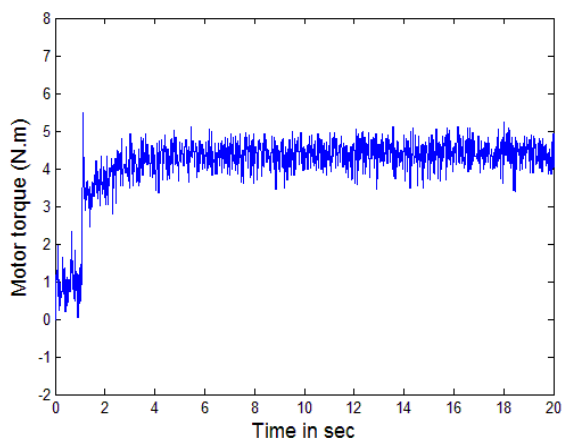

Fig.24 The estimated motor torque with modified method

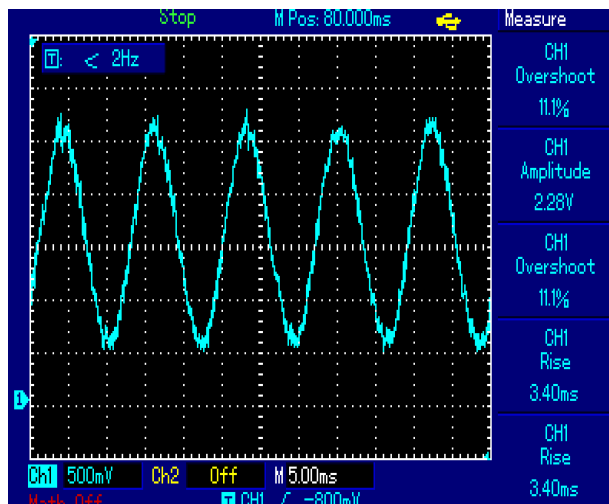

Fig.28 The motor current with modified method

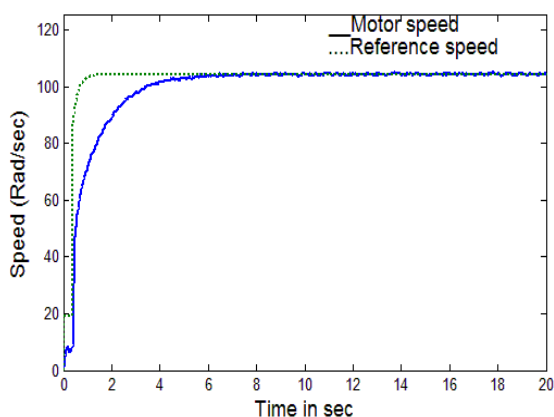

Fig.25 The motor speed with classical method

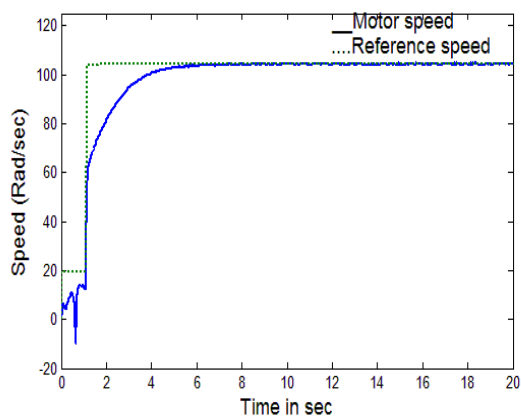

Fig.26 The motor speed with modified method

B. Second case of study

In this case; the motor is approximately starting with 50% of the rated load. Experimental results for the hysteresis current controller under sudden applied and removal the load are shown in the following Figs.

Motor torque for classical modified methods are shown in Fig. 29 and Fig. 30 respectively. From these Figs it is found that, The distortion in the modified method are reduced comparing to classical method.

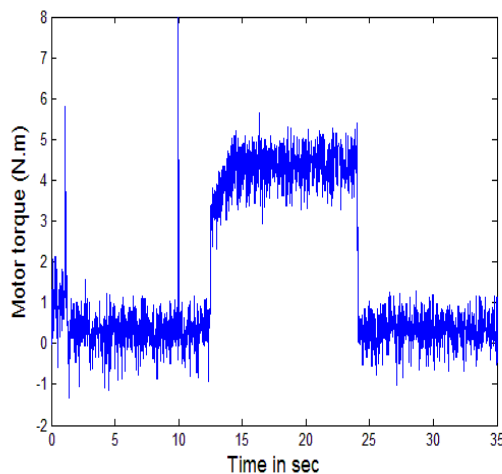

Fig.29 The estimated motor torque with classical method

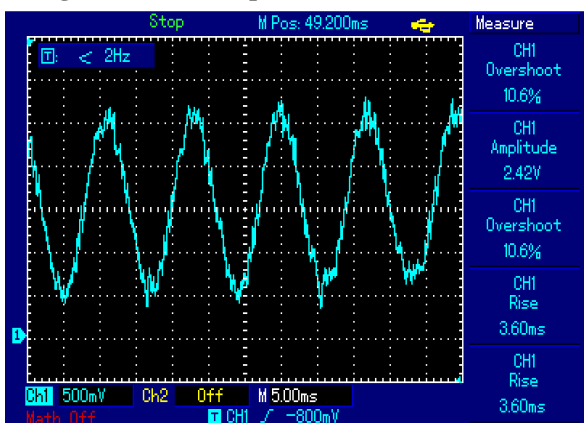

Fig.27 The motor current with classical method

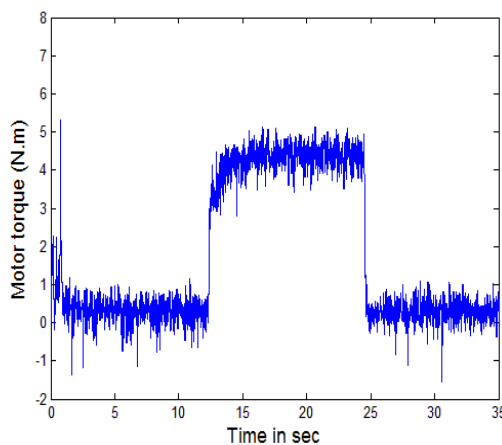

Fig.30 The estimated motor torque with modified method

Modified PI Controller to Improve the Performance Characteristics of the PMSM

Motor speed for classical and modified methods are shown Fig. 31 and Fig. 32. From these Figs it is evident that, The noise in the modified method is decreased if it is compared to classical method but there are a higher under shooting and over shooting in case of sudden applying or removal the load for the two cases under study so the PI torque current controller is added for the two method of controls to decrease the over and under shooting. The result of adding PI torque current controller on the motor speed is discussed later.

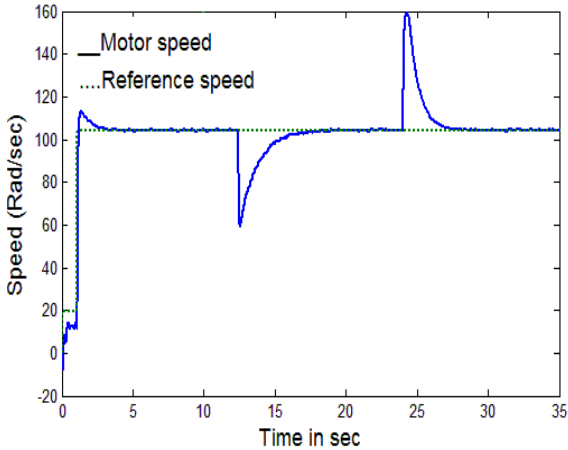

Fig. 31 The motor speed with classical method

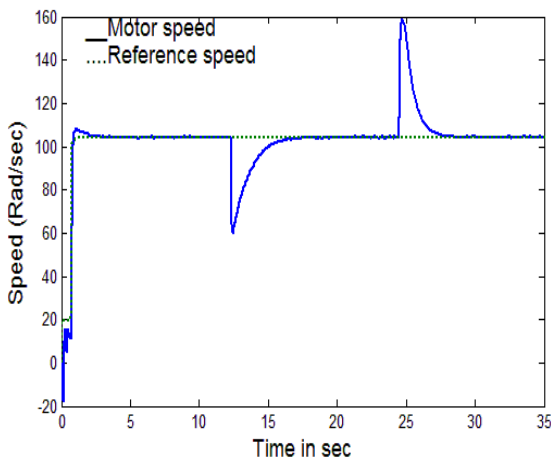

Fig. 32 The motor speed with modified method

Stator current of the motor for classical and modified methods are shown Fig. 33 and Fig. 34.

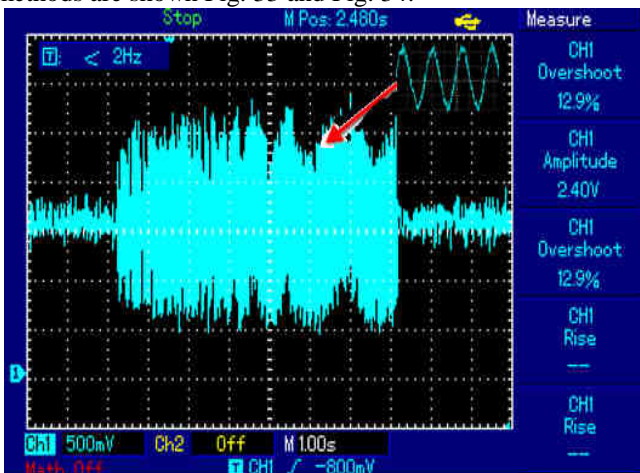

Fig.33 The motor current with classical method

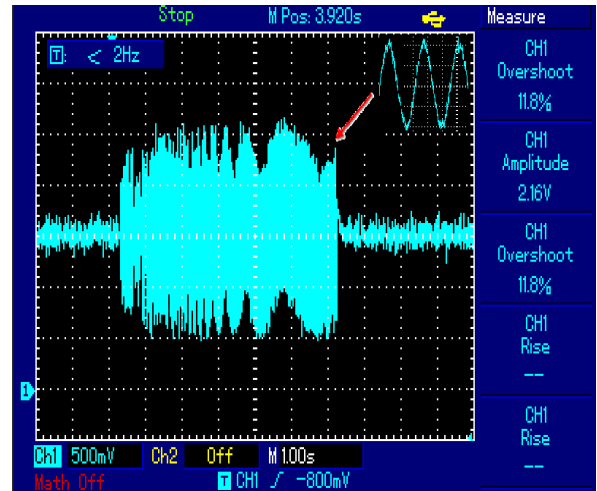

Fig. 34 The motor current with modified method

Where it is found that;

The motor current becomes smoother with modified method if it is compared to classical method.

From the last analysis it is found that;

At sudden applying or removal the load high under shooting and high over shooting occur to avoid this, the fourth PI controller which uses in the simulation is applied in the laboratory for modified method and classical method where from Fig. 35 for classical method and from Fig. 36 for modified method it is found that;

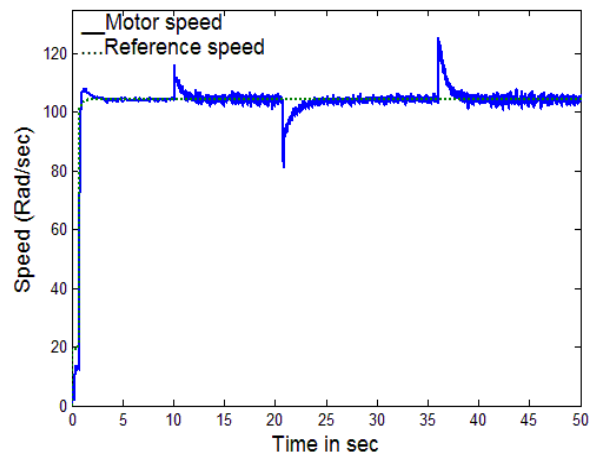

Fig. 35 The motor speed with classical method when fourth PI was used

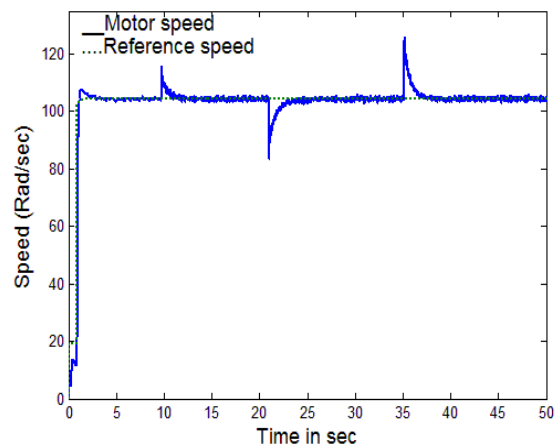

Fig.36 The motor speed with classical method when fourth PI was used

The first shooting is due to insert the forth PI controller in this time. When comparing the under and over shooting for this case in case of classical and modified method to the same case without using the forth PI it is evident that; the using of this PI is very important to decrease the over shooting and the under shooting.

Also the noise in the motor speed with modified method is less if it is compared to classical model.

VIII. CONCLUSION

The scope of this is to study the performance of the permanent magnet synchronous motor (PMSM) and trying to improve it. So the dynamic performance of PMSM is studied under effect of the vector control. These are occurred by designing the mathematical models, simulated of PMSM through the MATLAB and the simulating cases are studied in laboratory where it is found that;

1. The THD in the stator currents for modified method are reduced if it is compared to classical model.
2. The torque ripples are reduced for modified method are reduced if it is compared to classical model.
3. The motor speed and motor torque became reliable for modified method if it is compared to classical method.
4. The motor speed of the modified method is the lowest noise if it is compared to first classical method.
5. Use of the PI current controller in the vector control block leads to reduce the effect of sudden applied or removal the load in the two methods of control.

“Table 1”

Method of control	THD in current %	Torque ripples %
Classical VC	4.22	2.54
Modified VC	0.43	0.29

IX. APPENDIX (I)

MOTOR DATA OF SMPMSM

Line to line voltages	110V
Inertia	0.001118Kg.m ²
Magnetic flux linkage	0.108Wb
Pole pairs	5
Rated power	900W
Rated speed	1000 R.P.M
Stator resistance	0.43ohm
q-axis inductance	6.97mH
d-axis inductance	6.97mH

REFERENCE

1. Goed, I. da Silva and P. Jose, A. Serni, “A hybrid controller for the speed control of a permanent magnet synchronous motor drive,” Control Engineering Practice, Vol. 16, Issue 3, pp. 260-270, March, 2008.
2. C. Mademlis and N. Margaris, "Loss minimization in vector-controlled interior permanent-magnet synchronous motor drives", Industrial Electronics, IEEE Transactions on, vol. 49, pp. 1344-1347, 2002.
3. Jian-Xin, S. K. Panda, P. Ya-Jun, L. Tong Heng, and b. H. Lam, "a modular control scheme for pmsm speed control with pulsating torque minimization", Industrial Electronics, IEEE Transactions on, vol. 51, pp. 526-536, 2004.
4. Jingtang zhang, Zhiyuan Liu and Run Pei, “Two-Degree-of-Freedom internal model control for AC servo system (Periodical style),”

- Transactions of China Electrotechnical Society, vol. 17, no. 4, pp. 45-48, 2002.
5. Shengxian Zhuang, Xuening Li and Zhaoji Li, “ The application in the speed regulating of asynchronous machine vector frequency changing based on adaptive internal model control (Periodical style),” Journal of University of Electronic Science and Technology of China, vol. 28,no.5, pp.502-504, 1999.
6. P. L. Jansen and R. D. Lorentz, "Transducerless position and velocity estimation in induction and salient AC machines", IEEE Trans. Ind. Applicat., vol. 31, pp. 240–247, Mar./Apr. 1995.
7. P. L. Jansen, R. D. Lorenz, and D. W. Novotny, "Observer-based direct field orientation: Analysis and comparison of alternative methods", IEEE Trans. Ind. Applicat., vol. 30, pp. 945–953, July/Aug. 1994.
8. M. P. Kazmierkowski, and L. Malesani, "Current control techniques for three-phase voltage-source PWM converters: a survey", IEEE Trans. Ind. Electron., vol. 45, no. 5, October, 1998, pp. 691-703.
9. B. k. Bose, "An adaptive hysteresis-band current control technique of a voltage - fed PWM inverter for machine drive system", IEEE Trans., on Ind. Appl., Vol.IA-37, pp.402-408, 1990
10. Hamdy Mohamed soliman and S. M. EL. Hakim," Improved Hysteresis Current Controller to Drive Permanent Magnet Synchronous Motors Through the Field Oriented Control", International Journal of Soft Computing and Engineering , Vol. 2, No. 4, September 2012, pp. 40-46.



Dr. Hamdy Mohamed Soliman was born in Cairo-Egypt on 26 December 1970, He received B. Sc. in Electrical Power and Machine Engineering from Helwan University in 1993 and PhD Degree from Cairo University, Giza, Egypt in 2016. He is a director of development and research of train units in Egyptian company metro. His current research interests include motor control and drive system.