

See discussions, stats, and author profiles for this publication at: <https://www.researchgate.net/publication/315447660>

Optimum Remedial Operation of Permanent Magnet Synchronous Motor

Article in *International Journal of Electrical and Computer Engineering* · September 2012

DOI: 10.11591/ijece.v2i5.725

CITATIONS

3

READS

23

2 authors:



Hamdy Mohamed

Marg High Institute For Engineering And Modern Technology

27 PUBLICATIONS 45 CITATIONS

[SEE PROFILE](#)



Samia El-Hakim

Cairo University

4 PUBLICATIONS 28 CITATIONS

[SEE PROFILE](#)

Some of the authors of this publication are also working on these related projects:



high dynamic performance of permanent magnet synchronous motor with field oriented control [View project](#)



Identification of Stator Winding Faults and Remedial Operation of Permanent Magnet Synchronous Motors with Suppress Noise and Ripple [View project](#)

Optimum Remedial Operation of Permanent Magnet Synchronous Motor

Hamdy Mohamed Soliman*, S. M. EL. HAKIM**

*General Manger in Cairo Metro Greater

**Department of Electrical Power and Machines Engineering
Cairo University Egypt

Article Info

Article history:

Received Jun 30, 2012

Revised Sep 11, 2012

Accepted Sep 30, 2012

Keyword:

Field Oriented Control

Remedial Operation

PI Controller

Torque Ripple

THD

ABSTRACT

In critical systems, the reliability of the drive is very important. The faults are unwanted. The faults may be lead to loss of the human life and capital. This paper is addressed this problem and suggested two models to solve it. The first model doesn't contain any special tools to improve the torque ripple and THD. The second model contains 2PI current controllers to improvement the performance at fault and remedial operation. One is for the torque and the other is for the flux. The first PI controller is feeding from the torque error between the reference and estimated torques to get new q-axis current component representing modifier current arises from uncertain things inside the machine and drive system such as temperature and parameters variations. This current will add to reference q-axis current to get robust new q-axis current to satisfy the drive requirement and solve the torque problem (ripple torque). With robust current, the total harmonic distortion is a decrease but doesn't reach the best value so the other PI controller is used to adjust the THD. In this PI controller, the d-axis flux is compared to rotor permanent magnet flux to solve this problem arises from non-sinusoidal of the magnetic flux. The output of the PI controller is introduced to the reference d-axis current. The new d-axis current will reach the best value of THD. The simulation of the second controller is compared to the simulation of first controller to show if the second controller strong or weak. Matlab simulink is used to simulate the drive system.

Copyright © 2012 Institute of Advanced Engineering and Science.
All rights reserved.

Corresponding Author:

Hamdy Mohamed Soliman,

General Manger in Cairo Metro Greater

Email: Hamdysoliman123@gmail.com

1. INTRODUCTION

Permanent magnet synchronous motors (PMSM) are widely used in many industrial applications due to have many advantages as: high efficiency, high power density and high-torque/inertia ratio. The method of motor control is very important in the drive system. This is because the operation of the PMSM under some methods of control is suffered from complicated coupling and nonlinear dynamic performance. This problem can be solved by field oriented control (FOC). PMSM with FOC emulates the separately excited DC motor. In this method of control, the stator current can be decoupled into flux and torque current components. They can be controlled separately. The field oriented control is highly performance with healthy phases but when fault occurs, the control loop will influence the behavior of the variable speed drive during the fault. The fault in the drive system may be loss one phase or more which leads to fall the performance or damage part or totally drive system. In critical systems such as transportation, aerospace, medical, military and nuclear power plants, the faults are unwanted. They lead to loss of the human life and capital. In these systems, the reliability of the drive is very important. It represents the primary selection in the pervious industrial applications. To improve it, the fault is detected, isolated and reconfiguration of control system is

applied to verify the drive requirements. The critical systems must be continued to operate even in presence fault. A number of studies have been reported in the literature investigating fault-tolerant motor drives. Brushless permanent magnet (PM) motor drives can have the capability of fault tolerance by minimizing the electrical, magnetic and thermal interaction between phases and adopting H-bridge inverter circuits for each phase [1-3]. A dual fault-tolerant motor drive system has been proposed in [4]. The fault tolerant power electronic circuit topology to improve the reliability of the motors is studied in [5]. [6] Advices to separate the phases. Mechanical separation, realized by having one slot per winding, prevents from having inter-phase short circuit. Electrical separation allows controlling phases independently, which is possible with a full bridge since phases are electrically separated. In [7-8] some compensation techniques for open-circuited fault were proposed to improve the fault-tolerant performance of multiphase rotor-PM brushless motor drives. Reliability can be improved by special motor designs [9-10] or by means of remedial operation strategies [11-12]. Due to faults the performance is dragged so there are many methods to minimize the secondary effects on the machine during the faults as [13-15]. This paper is proposed the remedial strategy of the PMSM in fault case. To solve this problem, the monitoring and fault detection of the all drive system is vital. This occurs by monitoring the active or reactive power for each phase independently i.e. an appropriate model is compared to the measured active or reactive power to detect the abnormal operation. So the first step is detected the fault, the second step is isolated the faulty part and the third step is designing the reconfigurable inverter control. This paper is organized as follows. The first section is introduction. Section two PMSM and mathematical model are discussed. Section three H-bridge is for reliability. In section four, current controller method is explained. Section five shows the control structure. The simulation results are discussed in section six. The conclusion is in seven.

2. PMSM and MATHEMATICAL MODEL

Permanent magnet synchronous motor is similar to that of wound rotor synchronous motor. The rotor winding of synchronous motor is replaced with high resistivity permanent magnet material, hence, induced current in the rotor is negligible this means that, the rotor is lossless. The rotor types of PMSM are shown in Figure 1. The permanent magnets on the rotor are shaped in such a way as to produce sinusoidal back EMF in stator windings.

The d-q equivalent circuit model is a perfect solution to analyze the multiphase machine because its simplicity and intuition. Conventionally, a two phase equivalent circuit model instead of complex three phase model has been used to analyze PMSM but now complex three phase model has been used to analyze PMSM. This is because this model must be able to deal with several types of fault such as:

- a) Winding open-circuit.
- b) Winding short circuit (partial turn to turn or complete).
- c) Inverter switch open-circuit (analogous to winding terminal open-circuit).
- d) Inverter switch short-circuit (analogous to winding terminal short-circuit).
- e) Position sensor (which can be also used to speed sensing) or current sensor failure.
- f) Controller failure.
- g) Combination of the above faults.

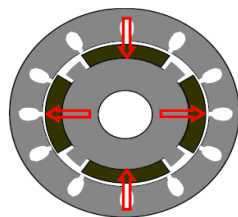

Figure 1.a. PMSM surface inset

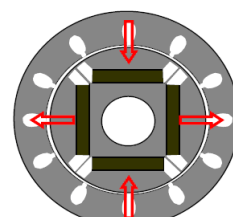

Figure 1.b. PMSM surface interior (buried)

Figure 1. The types of the rotor in PMSM

The voltage equations PMSM can be simplified as follows:

$$\begin{bmatrix} v_a \\ v_b \\ v_c \end{bmatrix} = r_s \begin{bmatrix} i_a \\ i_b \\ i_c \end{bmatrix} + L \frac{d}{dt} \begin{bmatrix} i_a \\ i_b \\ i_c \end{bmatrix} + \begin{bmatrix} e_a \\ e_b \\ e_c \end{bmatrix} \quad (1)$$

Where $[v_a v_b v_c]^T$ is stator a voltage, $[i_a i_b i_c]^T$ is a stator current and $[e_a e_b e_c]^T$ is a back-EMF

$$r_s = \begin{bmatrix} r_s & 0 & 0 \\ 0 & r_s & 0 \\ 0 & 0 & r_s \end{bmatrix}, L = \begin{bmatrix} L_s & M & M \\ M & L_s & M \\ M & M & L_s \end{bmatrix} \quad (2)$$

Where r_s is a stator resistance, L_s is a self inductance and M is mutual inductance between winding. The ideal back-EMF waveforms for sinusoidal PM motor can be expressed as:

$$\begin{bmatrix} e_a \\ e_b \\ e_c \end{bmatrix} = -E_m \begin{pmatrix} \sin(\theta_e) \\ \sin(\theta_e - 120) \\ \sin(\theta_e - 240) \end{pmatrix} \quad (3)$$

The peak value of induced voltage E_m is proportional to the electrical angular speed and can be calculated as

$$E_m = \Psi_m \omega_r \quad (4)$$

The electromagnetic torque can be expressed as:

$$T_e = -p \Psi_m (i_a \sin(\theta_e) + i_b \sin(\theta_e - 120) + i_c \sin(\theta_e - 240)) \quad (5)$$

Due to mechanical system, the dynamic model of rotor drive system can be given as

$$T_e = T_L + \beta \omega_r + \frac{J}{P} \frac{d\omega_r}{dt} \quad (6)$$

Where Ψ_m , J , T_L , β and P denote the rotor permanent magnet flux moment of inertia, external load torque, viscous friction coefficient of the rotating parts and poles of machine, respectively.

3. H-BRIDGE IS FOR RELIABILITY

An H-bridge inverter circuit is an electronic power circuit that allows motor speed and direction to be controlled. It is used to driving each motor winding separately so a failure in one winding will not affect the operation of the remaining windings. It is used in the application requiring a high rate of reliability. It is the best choice for working in high voltage and high-power applications. It is operating with low switching frequency so its losses can be minimized. It offers maximum of redundancy. Each H-bridge consists of four power switches (with anti-parallel diodes). Figure 2 shows the PMSM when fed from separate phases, each phase being fed by an H bridge. During the fault, the faulty H-bridge is isolated and the control can be configuration and the other H-bridges can be modified by gating signals. The disadvantages of these H-bridges are multiple switches.

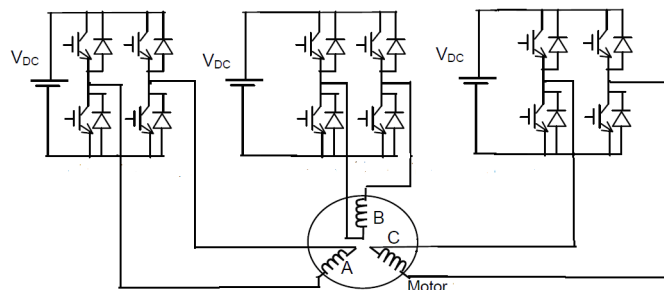

Figure 2. Feeding PMSM from separate phases

4. CURRENT CONTROLLER METHOD

In this work, the current control of converter is a hysteresis current controller. It is used due to simple, fast dynamic response and insensitive to load parameters. Figure 3 represents the hysteresis current controller. In this method each phase consists of comparator and hysteresis band. The switching signals are

generated due to error in the current. The error comes from comparing between the reference current and actual current. The main task of this method of control is to force the input current to follow the reference current in each phase. The deviation of the current between the upper and lower in the hysteresis band is limited. In any phase, if the actual current becomes more than the upper limit of hysteresis band ($i_{ref} + HB$) the upper switch of the inverter arm is turned off, the lower switch is turned on and the current starts to decay. In contrast if the actual current reaches lower limit or less than of hysteresis band ($i_{ref} - HB$) the lower switch of the inverter arm is turned off, the upper switch is turned on and the current comes back into the hysteresis band. The band width calculates the switching frequency and current ripple. The band width is directly proportional to current ripple and inversely proportional to switching frequency so the selection of the band width means performance of inverter. This is because the increasing in the band width will increase the current ripple in contrast; a decrease in the band width will increase the switching losses.

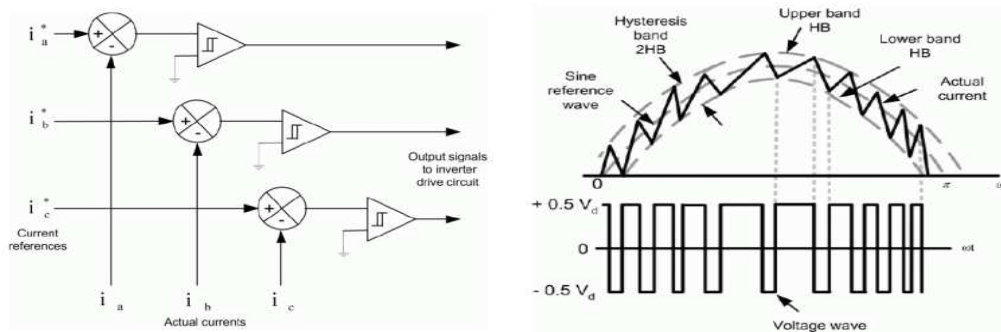

Figure 3. Hysteresis current controller basic structure and concept

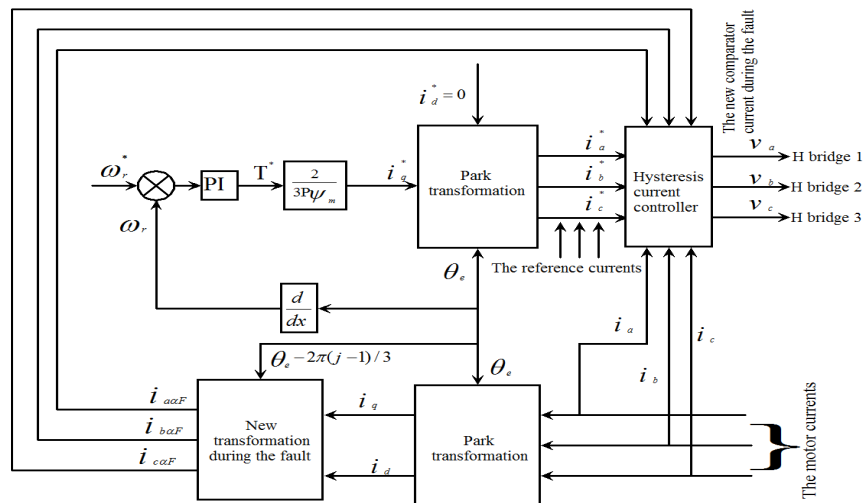

Figure 4. Remedial operation of PMSM at fault (first model)

5. THE CONTROL STRUCTURE

Here two proposals control are used for remedial operation of PMSM. The first control is shown in Figure 4. where the second control is in Figure 5.

In the first control, the maximum torque can be performed by equating the q-axis current with the stator current so the regulation of this current is very important to get the desired torque. This can be done through the drive scheme. The drive is influenced by uncertainties, electromagnetic interface, non-sinusoidal of stator current and permanent magnet rotor flux or all of them. They reflect on the torque and current causing unwanted problems such as ripple and noise. So the PI speed controller which is used to generate the q-axis current isn't sufficient to overcome the noise and ripples in torque and current. To minimize the ripple, noise and harmonics in the torque another PI controllers are used; the input of the new PI controller is the error in the torque. This error comes from the output of comparator which comparing the reference torque

to estimated torque. The output of the new PI controller is a new q-axis current (i_{qMOD}) which represents the torque problems. This current is adding to the reference of q-axes current to get robust current (i_{qNew}).

The robust current satisfies requirements of the drive system. With this enhanced in the q-axis current component, the distortion of the current doesn't reach the best value. To reach the best value another PI controller is used. The input of this PI controller arises from comparing the estimated d-axis flux with permanent magnet flux. The output of this PI controller is added to the reference d-axis current which is forced to zero at constant flux region. The new d-axis current is reduced. So the first control (FOC) with adding 2PI current controllers (one for the torque and the other for the flux) is a good performance at healthy phases but when fault occurs the performance is deteriorate significantly unless proper remedial strategies are undertaken. So this controller is modified to verify highest performance in fault case. In the proposed control, the motor can be controlled phase by phase. This control is isolated the fault phase and reconfiguration the stator currents depending upon the fault case which is compared to the reference currents to apply new voltages on the healthy phases. This makes the motor with fault is able to drive the drive system without any problem. With fault, the sum of the phases current isn't equal to zero. This controller can be done by adding two blocks. One changes the stator current in the stationery reference frame (A,B,C) to rotor reference frame (d,q) and the other consists in building for each phase of motor into α phase. Each phase can be built as;

$$i_{\alpha j} = i_d \cos(\theta_e - 2\pi(j-1)/3) - i_q \sin(\theta_e - 2\pi(j-1)/3) \quad (7)$$

6. SIMULATION RESULTS

Here the following faults are study: one phase open circuit, one phase short circuit, and sensor failure. In all simulation cases, the motor start without fault, at 0.1 sec, the fault occurs without remedial strategies, at 0.2 sec, the faulty phases is isolated and at 0.3 sec, the remedial strategies are applied. This occurs to show the effect of remedial strategies on the performance of the motor during the fault. With remedial strategies the torque ripple and THD become improvement if it is compared to the fault case before applying it but when compared to the healthy case, it is found that, the torque ripple and THD must be get rid to reach the highest performance during the fault case. So they must be approximately vanish. This occurs through using 2PI controller one for the torque and the other for the flux. The proposal model is to verify the remedial strategies (model one) is acceptable but when adding the 2PI current controller the performance became highest (model two). Here the model two is compared to the model one to show the effectiveness of model two in the drive performance with fault case. The measured value of the torque ripple and THD at healthy phases, at faulty phases and remedial strategies in two models are shown in tables 1,2, 3 and motor parameters in appendix 1

6.1. Case one, the open circuit fault

It is a common motor fault. It can be detect by measuring the motor current and voltage i.e. detection the active or reactive power for each phase independently. The motor torque when phase (a) is open can be calculated by putting the current in that phase equal zero in (5) then

$$T_e = -p \Psi_m \left[i_b \sin(\theta_e - 120) + i_c \sin(\theta_e - 240) \right] \quad (8)$$

The active or reactive power for fault phase is shown in Figure 6 where it is evident that, at fault these powers became zero and this can be taken as indicator at fault case.

Figures (7-8) show the effect of one phase open circuit (phase a) in the two models on the dq-axes currents. When fault occurred, dq-axis currents are distorted. Highly distorted occurs with using model one (Figure 7) while with model two (Figure 8) the distortion is decreasing. With applying the remedial strategies dq-axes currents are improved in two models but the best value occurred with model two.

Figures (9-10) show the motor torque under fault where it is evident that, when phase (a) is open, the ripples torque increases and this is harmful for motor. It arises due to an increase in harmonics, noise and electromagnet interface. In first model, the ripple torque increases as shown in Figure 9 this ripple is decreasing with second model as shown in Figure 10. With applying the remedial strategies the oscillation is decaying but doesn't reach the best value with model one but in second model the oscillation is approximately vanish.

Figure 11 shows some noise and oscillation in the speed with first model at fault this noise and oscillation are approximately vanish with second model (Figure 12). At remedial operation with two models, the oscillation can be neglected.

The stator currents become smoother with second model due to reduction of the noise and suppress the harmonics (Figure 14) if it is compared to model one (Figure 13) also the stator current with second model is less. At remedial strategies the higher current in the remaining phases aren't quite dangerous add to that the windings don't affect by this rise in the current due to the motor with remedial strategies doesn't saturate.

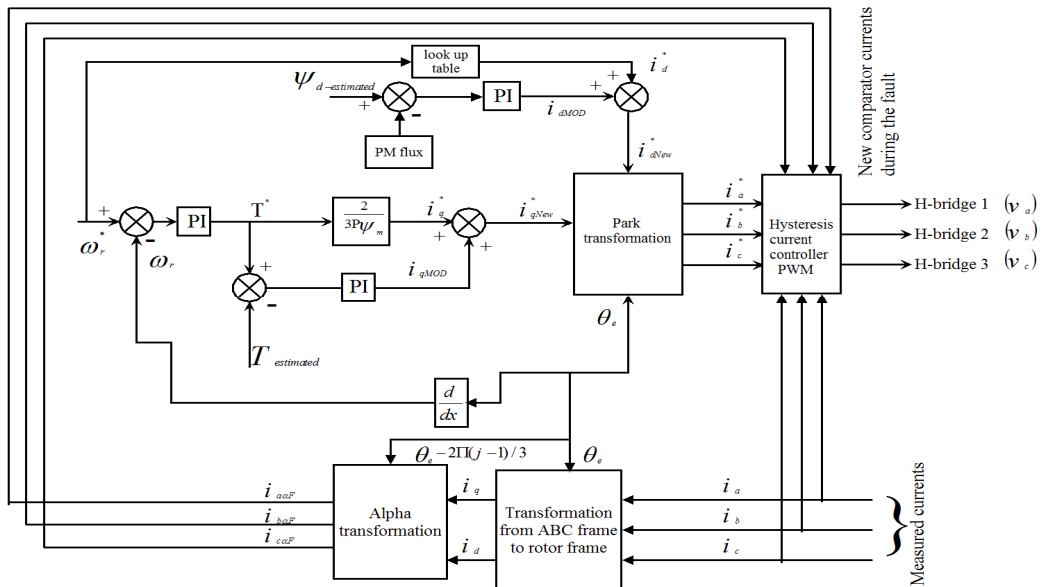

Figure 5. Remedial operation of PMSM at fault (second model)

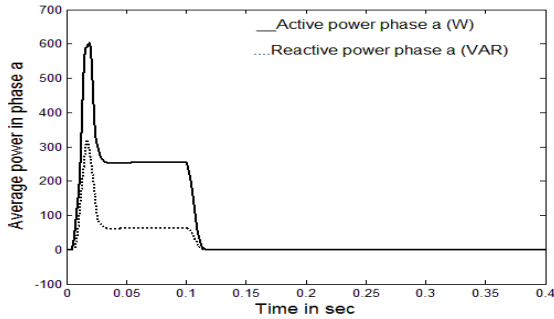

Figure 6. Active reactive power to detect the open phase fault

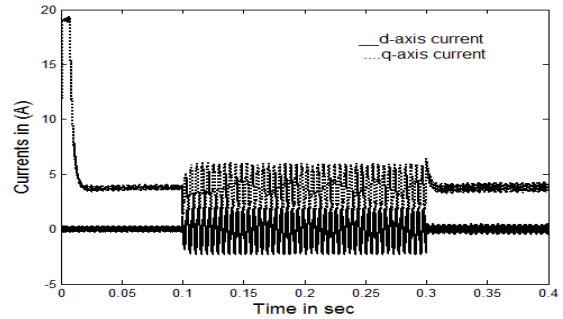

Figure 7. Idq -axis current without modified PI controller for torque and flux

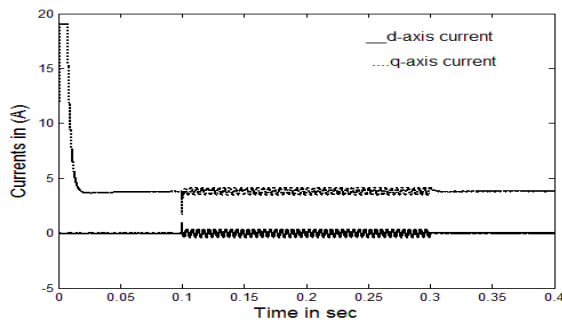

Figure 8. Idq -axis current with modified PI controller for torque and flux

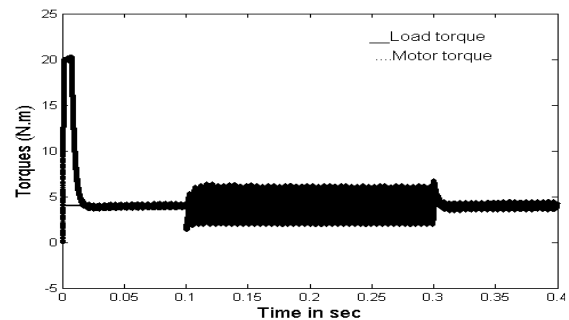

Figure 9. Torque without modified PI controller for torque and flux

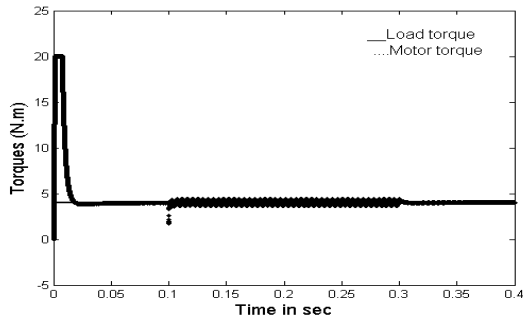

Figure 10. Torque with modified PI controller for torque and flux

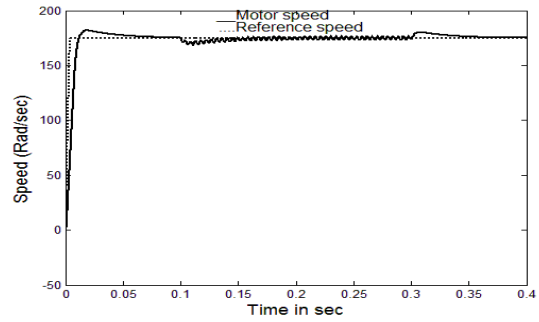

Figure 11. Speed without modified PI controller for torque and flux

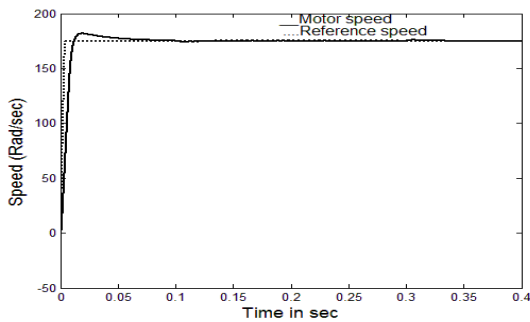

Figure 12. Speed with modified PI controller for torque and flux

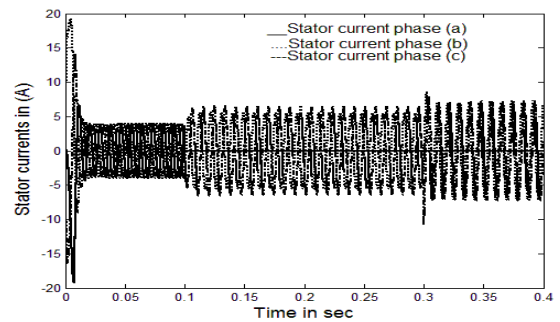

Figure 13. Stator current without modified PI controller for torque and flux

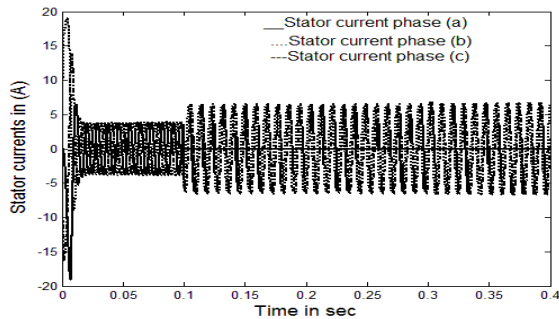

Figure 14. Stator current with modified PI controller for torque and flux

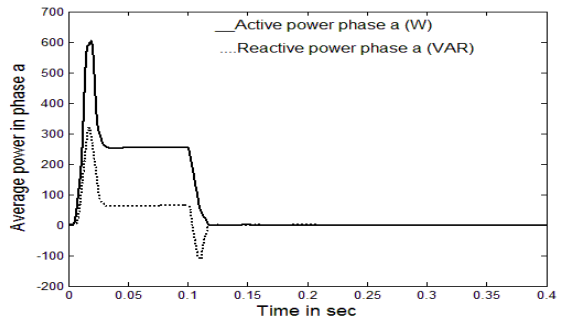

Figure 15. Active reactive power to detect the short circuit phase fault

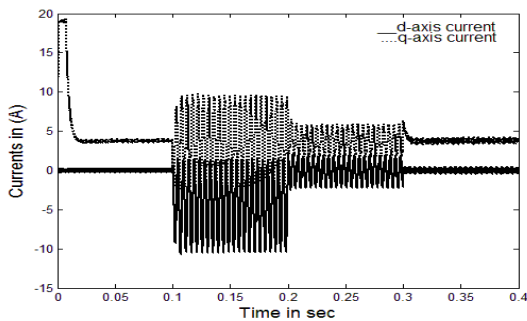

Figure 16. Idq-axis current without modified PI controller for torque and flux

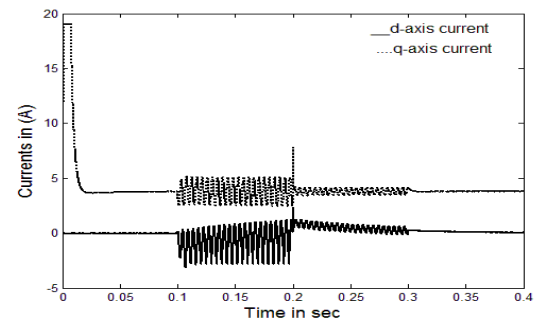

Figure 17. Idq-axis current with modified PI controller for torque and flux

6.2. Case two, the short circuit fault

It is a critical motor fault so the faulty phase must be isolated. It is a very dangerous on the motor and causes serious problems on the motor and drive system. This fault can be avoided by impeding higher impedance in the fault phases circuit. The steady state short circuit current can be calculated as

$$I_{sc} = \frac{E_m}{\sqrt{r_s^2 + \omega_e L_s}} \tag{9}$$

The active or reactive power for fault phase is shown in Figure 15 at fault these powers became zero.

Figures (16-17) show the effect of one phase short circuit (phase a) in the two models on the dq-axes currents. At fault, dq-axis currents are highly distorted. Figure 16 shows higher distortion with using model one while the distortion is a decrease with model two (Figure 17). With applying the remedial strategies dq-axes currents are improved in two models but the best value occurred with model two

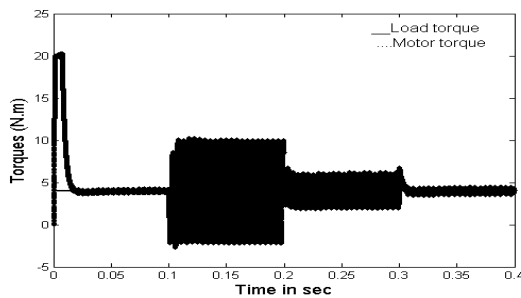

Figure 18. Torque without modified PI controller for torque and flux

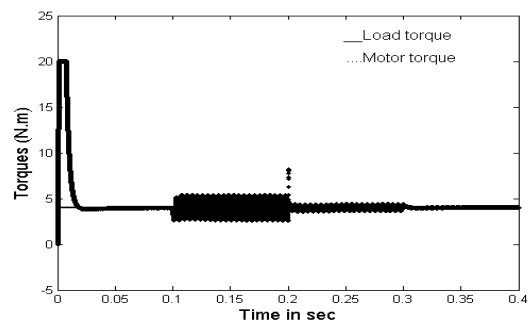

Figure 19. Torque with modified PI controller for torque and flux

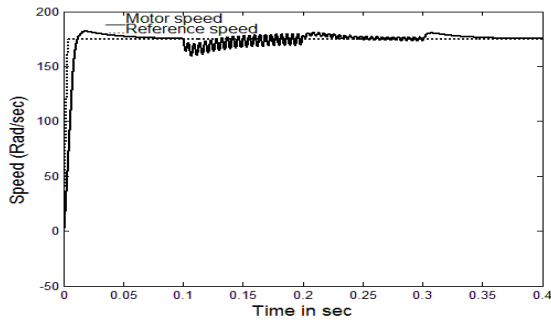

Figure 20. Speed without modified PI controller for torque and flux

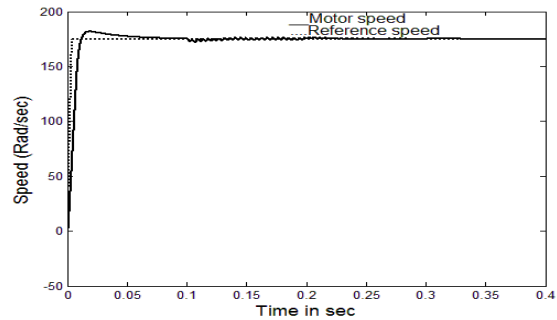

Figure 21. Speed with modified PI controller for torque and flux

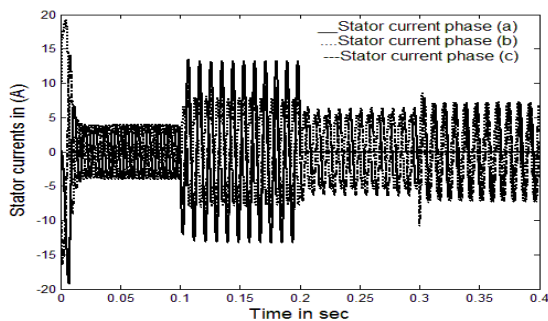

Figure 22. Stator current without modified PI controller for torque and flux

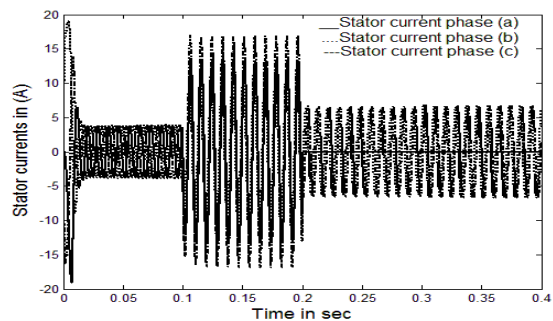

Figure 23. Stator current with modified PI controller for torque and flux

In the first model, the ripple torque increases as shown in Figure 18 due to an increase in harmonics, noise and electromagnet interface this ripple is decreasing with second model as shown in Figure 19. With applying the remedial strategies the oscillation is decaying but doesn't reach the best value with model one. The oscillation is approximately vanish with second model.

Figure 20 shows highly noise and oscillation in the speed with first model at fault this noise and oscillation are approximately vanish with second model (Figure 21). At remedial operation with two models, the oscillation can be neglected.

At fault, the short circuit current is to dangerous this fault can be damaged the motor so it very important isolated it quickly. The stator currents become smoother with second model due to reduction of the noise and suppress the harmonics Figure 23. if it is compared to proposal one Figure 22. at remedial strategies the stator current with second model is less.

6.3. Case three, the sensor current fault

Monitoring an active or reactive power for fault phase is shown in Figure 24 where it is evident that, at sensor current fault these measured powers due to sensor became zero so this phase must be isolated.

Figures (25-26) show dq-axes currents under one sensor fault (phase a). In first model, the ripple and oscillation increases as shown in Figure 25 but with second model they are decreased (Figure 26). With applying the remedial strategies the oscillation and ripple are decayed and reach to the best value with second model.

Figures (27-28) show the motor torque under fault, the ripples torque is to highly increasing and reshaped very harmful for the motor. This comes from highly increasing in harmonics, noise and electromagnet interface in first model (Figure 27). With applying the remedial strategies the oscillation and ripple are decaying but doesn't reach the best value with model one but with second model the oscillation and ripples torque are approximately vanish as shown in Figure 28. some highly noise and oscillation in the speed with first model at fault (Figure 29). This noise and oscillation are approximately vanish with second model Figure30. At remedial operation the oscillation can be neglected.

The stator current is very dangerous at fault with model one (Figure31). With remedial strategies the current becomes acceptable but this current reaches to the best value with model two (Figure32).

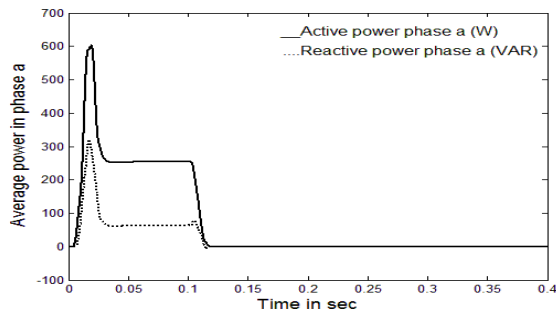

Figure 24. Active reactive power to detect the open phase fault

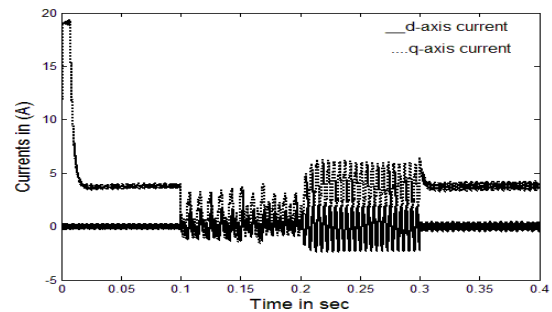

Figure 25. Idq -axis current without modified PI controller for torque and flux

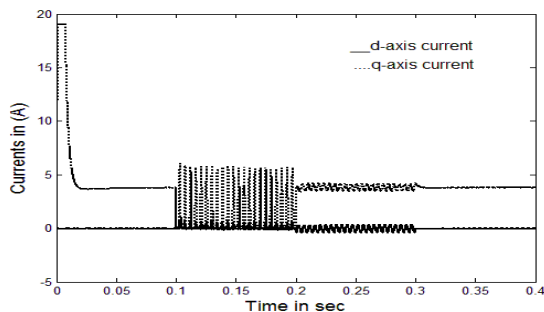

Figure 26. Idq -axis current with modified PI controller for torque and flux

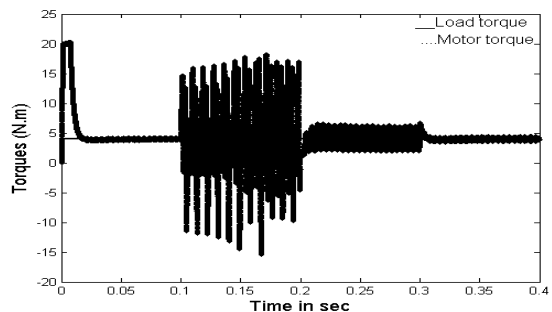

Figure 27. Torque without modified PI controller for torque and flux

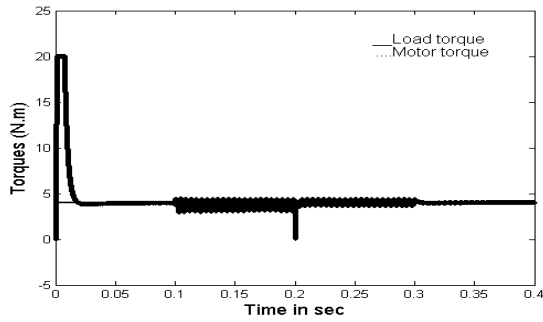

Figure 28. Torque with modified PI controller for torque and flux

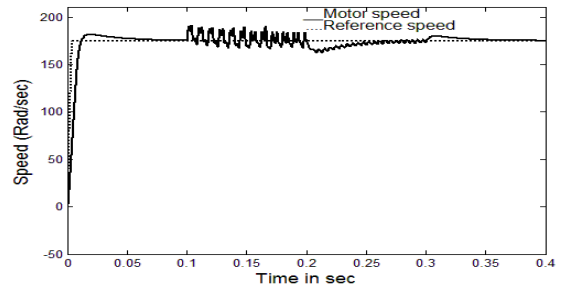

Figure 29. Speed without modified PI controller for torque and flux

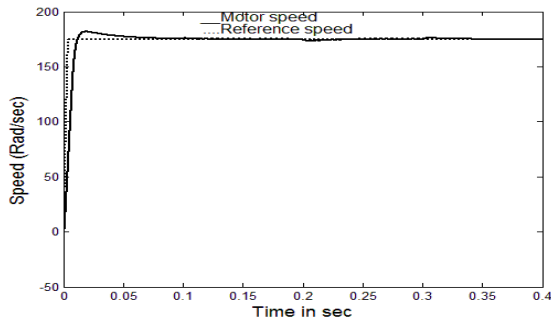

Figure 30. Speed with modified PI controller for torque and flux

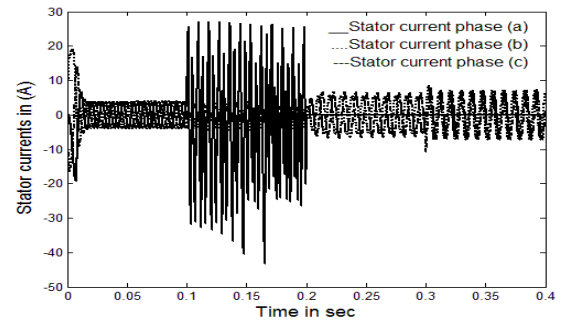

Figure 31. Stator current without modified PI controller for torque and flux

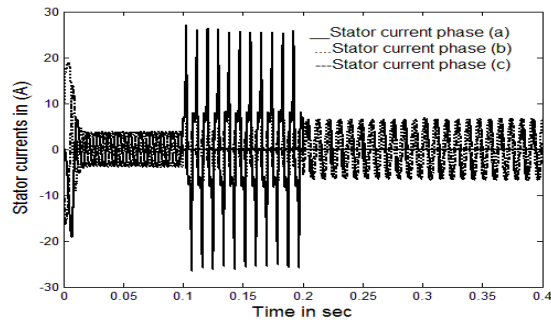

Figure 32. Stator current with modified PI controller

Table 1. Torque Ripples and THD in Case of Healthy Phases for Model One and Model Two

Case of study	Torque ripples %		THD %	
	Model one	Model two	Model one	Model two
Healthy phases	3.1	0.45	5.49	0.7

7. CONCLUSION

The faults (open circuit, short circuit and current sensor failure) are discussed, two proposals method are used to verify remedial operation of PMSM. One is for remedial operation only and the other for remedial operation with improvement the ripple torque and THD. The simulation shows that, at remedial strategies, the results are acceptable for two models. With adding 2PI current controllers the performance becomes superior.

Table 2. Torque Ripples in Case of Faulty Phases for Model One and Model Two

Fault case	Torque ripples %					
	At fault	Model one At separation the faulty phase	Remedial operation	At fault	Model two At separation the faulty phase	Remedial operation
One phase open circuit	35	35	4.5	3.63	3.63	0.46
One phase short circuit	105	35	4.5	6.3	3.63	0.46
One sensor current failure	160	35	4.5	3.6	3.63	0.46

Table 3. THD in Case of Faulty Phases for Model One and Model Two

Fault case	THD %						
	At fault	At separation the faulty phase	Model one	Remedial operation	At fault	Model two	Remedial operation
One phase open circuit	6.3	6.3	6.3	6.2	1.45	1.45	0.75
One phase short circuit	12.2	6.3	6.3	6.2	6	1.45	0.75
One sensor current failure	85	6.3	6.3	6.2	2.6	1.45	0.75

APPENDIX 1

Rated torque 4 N.M, Rated speed 175 Rad/Sec, Permanent magnet flux 0.175 Wb, phase stator resistance 2.875Ω , phase self inductance 12.5 mH, phase mutual inductance 4.5 mH, and rotor inertia 0.0008 Kg.m^2

REFERENCES

- [1] B. C. Mecrow, A. G. Jack, J. A. Haylock, J. Coles, "Fault-tolerant permanent magnet machine drives", IEE Proceedings on Electric Power Applications, Vol. 143(6), Nov. 1996, pp. 437-442.
- [2] J. A. Haylock, B. C. Mecrow, A. G. Jack, and D. J. Atkinson, "Operation of a fault tolerant PM drive for an aerospace fuel pump application", IEE Proceedings on Electric Power Applications, Vol. 145(5), September 1998, pp. 441-448.
- [3] B. C. Mecrow, A. G. Jack, D. J. Atkinson and S. R. Green, "Design and testing of a four-phase fault-tolerant permanent-magnet machine for an engine fuel pump", IEEE Transactions on Energy Conversion, Vol. 19(4), Dec. 2004, pp. 671-678.
- [4] N. Ertugrul, W. Soong, G. Dostal, and D. Saxon, "Fault tolerant motor drive system with redundancy for critical application", IEEE Power Electronics Specialists Conference, Cairns, June 2002.
- [5] Dinyu Qin, Xiaogang Luo, and T. A. Lipo, "Reluctance Motor Control For Fault - Tolerant Capability", IEEE IEMDC '97, Milwaukee, WI, USA, 1997.
- [6] Mecrow B.C., Jack A.G., Haylock J.A. and Coles J., "Fault Tolerant Permanent Magnet Machine Drives", IEE Proceedings Electric Power Application; Vol 143, No. 6, pp 437-441
- [7] L. Parsa and H. A. Toliyat, "Fault-tolerant interior-permanent-magnet machines for hybrid electric vehicle applications," IEEE Trans. Veh. Technol., vol. 56, no. 4, pp. 1546-1552, Jul. 2007.
- [8] N. Bianchi, S. Bolognani, and M. D. Pre, "Impact of stator winding of a five-phase permanent-magnet motor on postfault operations," IEEE Trans. Ind. Electron., vol. 55, no. 5, pp. 1978-1987, May 2008.
- [9] Jahns, T. M.: "Improved Reliability in Solid-State AC Drives by Means of Multiple Independent Phase-Drive Units", In: IEEE Trans. on Ind. Appl., Vol. IA-16, No. 3, May/June 1980, pp. 321 - 331
- [10] Mecrow, B. C. et al.: "Fault-tolerant Permanent Magnet Machine Drives", In: IEE Proc. - Electr. Power Appl. Vol 143, No. 6, 1996, pp. 437 - 441
- [11] Spée, R.; Wallace, A. K.: "Remedial Strategies for Brushless DC Drive Failures", In: IEEE Trans. on Ind. Appl., Vol. 26, No. 2, 1990
- [12] Elch-Heb, T.; Fan, Y.; Hautier, J. P.: "Reliability Improvement of Field-oriented Controlled Three-phase AC Drives by Means of Two-phase Remedial Operation", In: Proc. Int. Conf. on Electric Machines (ICEM), Paris, 1994, vol. 2, pp. 194 - 198.
- [13] W. Qian and S. K. Panda, "Torque Ripple Minimization in PM Synchronous Motors Using Iterative Learning Control" IEEE Trans, VOL. 19, NO. 2, MARCH 2004
- [14] A. A. Adam And K.Gulez, "A New Sensorless Hysteresis Direct Torque Control Algorithm for PMSM with Minimum Torque Ripples", COMPEL, Vol.28, No.2, April 2009
- [15] M. Saafan, A. Haikal, S. Saraya, F. Areed: "Adaptive Control for Torque Ripple Minimization in PM Synchronous Motors" International Journal of Computer Applications, Volume 37- No.5, January 2012.