

See discussions, stats, and author profiles for this publication at: <https://www.researchgate.net/publication/320555576>

Effect of the Parameters Variation for Induction Motor on its Performance Characteristics with Field Oriented Control Compared to Scalar Control

Article · August 2016

CITATIONS

2

READS

803

3 authors, including:



Hamdy Mohamed

Marg High Institute For Engineering And Modern Technology

27 PUBLICATIONS 45 CITATIONS

SEE PROFILE

Some of the authors of this publication are also working on these related projects:



high dynamic performance of permanent magnet synchronous motor with field oriented control [View project](#)



Identification of Stator Winding Faults and Remedial Operation of Permanent Magnet Synchronous Motors with Suppress Noise and Ripple [View project](#)

Effect of the Parameters Variation for Induction Motor on its Performance Characteristics with Field Oriented Control Compared to Scalar Control

Hamdy Mohamed Soliman

Egyptian Cairo Metro
Email: hamdysoliman123@gmail.com

Abstract—With inventing the semiconductor devices and control theories, the induction motors are placed the DC motor in the industrial applications. There are many control methods are used to control the induction motor as scalar control and field oriented control. The motor parameters which used inside control must be matched with actual motor parameters to achieve high dynamic response. So this paper is used to study the effect of the parameters variation for induction motor on the performance characteristics of its with field oriented control compared to scalar control at starting point and at full load point. In this paper, the skin effect is taken into consideration. This study is occurred in the constant flux region and in the field weakening region. MATLAB program is used to simulate this study.

Keywords— *Field oriented control, Induction motor, Parameters variation, Scalar control.*

I. INTRODUCTION

Induction motor is used in many industrial applications due to have low cost, low maintenance, high efficiency, rugged structure and long operation life at medium and high loads. The control methods for electrical machine are different from method to another method. In these methods of control some machine parameters must be very well to get high dynamic performance. These parameters are not constant and differ from operating point to another operating point i.e. these parameters are affected by temperature, saturation, frequency and skin effect. So this paper is importance to the effect of the all parameters variation of induction motor with field oriented control (FOC) and with scalar control (SC) at constant flux region and at field weakening region at starting point and at full load point. In the scalar control, the portion of voltage and frequency are kept constant as a magnitude to keep the airgap motor flux constant which means that constant motor torque [1-5]. This motor torque is at rated this is because the motor flux is constant. In the above rated speed (field weakening region), the frequency varies and the applied motor voltage is kept constant so the motor torque is inversely proportional to speed due decrease of the flux. In the closed loop scalar control some parameters are needed to avoid the saturation and getting the good slip speed. The saturation may be occurred due to the motor may be under excited or over excited depending upon the region which working in it. Also FOC saves high dynamic performance for AC drives this because the AC machine with FOC emulate the DC motor i.e. the stator and rotor flux are perpendicular. In this control type, the portion of voltage and flux is constant in the constant flux region as SC but the machine parameters such as flux, current and voltage are controlled as the vector in the space [6-9]. Also above the base speed, the motor voltage is kept constant and frequency increase as SC control and the machine parameters (flux, current and voltage) are controlled as the vector in the space. In spite of the FOC is good control and saves high dynamic performance but the high performance is lost when occurred mismatching between the motor parameters and the estimating motor parameters that are used in the control. So this paper is discussed the effect of parameters variation on the performance characteristics of induction motor with FOC compared to SC at starting and at full load. This paper concluded that, I introduction, II mathematical model, III scalar control, IV field oriented control and V simulation results VI conclusion.

II. MATHEMATICAL MODEL OF INDUCTION MOTOR

The mathematical model of induction motor in synchronous reference frame with taken into account the effect of core loss can be written as the follows

$$V_{ds}^s = R_s I_{ds}^s + \rho \Psi_{ds}^s - \omega_e \Psi_{qs}^s \quad (1)$$

$$V_{qs}^s = R_s I_{qs}^s + \rho \Psi_{qs}^s + \omega_e \Psi_{ds}^s \quad (2)$$

$$0 = R_r I_{dr}^s + \rho \psi_{dr}^s - (\omega_e - \omega_r) \psi_{qr}^s \tag{3}$$

$$0 = R_r I_{qr}^s + \rho \psi_{qr}^s + (\omega_e - \omega_r) \psi_{dr}^s \tag{4}$$

$$R_c I_{dc}^s = \rho \psi_{dm}^s - \omega_e \psi_{qm}^s \tag{5}$$

$$R_c I_{qc}^s = \rho \psi_{qm}^s + \omega_e \psi_{dm}^s \tag{6}$$

$$\psi_{ds}^s = L_{ls} I_{ds}^s + \psi_{dm}^s \tag{7}$$

$$\psi_{qs}^s = L_{ls} I_{qs}^s + \psi_{qm}^s \tag{8}$$

$$\psi_{dr}^s = L_{lr} I_{dr}^s + \psi_{dm}^s \tag{9}$$

$$\psi_{qr}^s = L_{lr} I_{qr}^s + \psi_{qm}^s \tag{10}$$

$$\psi_{dm}^s = M I_{dm}^s \tag{11}$$

$$\psi_{qm}^s = M I_{qm}^s \tag{12}$$

$$I_{dm}^s + I_{dc}^s = I_{ds}^s + I_{dr}^s \tag{13}$$

$$I_{qm}^s + I_{qc}^s = I_{qs}^s + I_{qr}^s \tag{14}$$

$$T_e = \frac{3}{2} \frac{P}{2} \frac{M}{L_{lr}} (\psi_{dr}^s I_{qm}^s - \psi_{qr}^s I_{dm}^s) \tag{15}$$

$$J_p \omega_r = T_e - T_e - B \omega_r \tag{16}$$

Based on the d-q voltages equations on synchronous reference frame, the d-q equivalent circuit can be drawn as shown in Fig. (1).

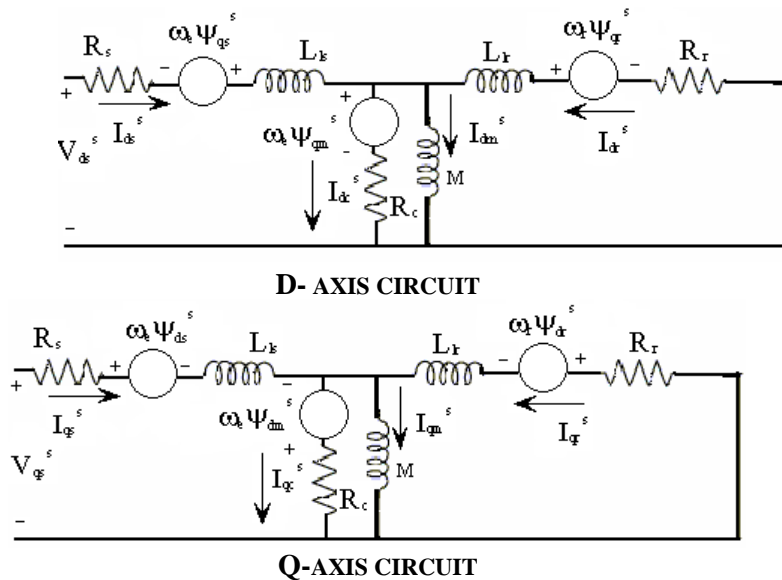

FIG. 1 THE EQUIVALENT CIRCUITS OF INDUCTION MOTOR IN SYNCHRONOUS FRAME

III. SCALAR CONTROL

Scalar control is a popular control due to simplicity and low cost. It is used in open loop and closed loop controls. To control in the motor speed, the frequency of the input voltage of the motor must be change. To keep the motor torque constant, the air-gap flux must be constant at rated frequency i.e. $\frac{v}{\omega_e}$ is kept constant. This ratio gives good control at nearer base

frequency because the voltage drop in the stator resistance can be neglected this is because this drop on the voltage doesn't exceed 5% of the input voltage but at low frequency this ratio cannot be neglected and the level of the flux is decay. The largest decrease in the flux makes the motor is saturated cannot get demand torque and the motor becomes over heated to avoid this, a boosting voltage is applied to compensate the drop in the stator resistance as shown in Fig. 2. i.e. to drive the induction motor through open loop SC, the reference speed is used to generating voltage and frequency that are suitable to drive the induction motor nearer to synchronous speed through the inverter and at low frequency, the boosting voltage is added to compensate the leak of the voltage due to effect of stator resistance. This method of control is very good when high dynamic performance isn't required.

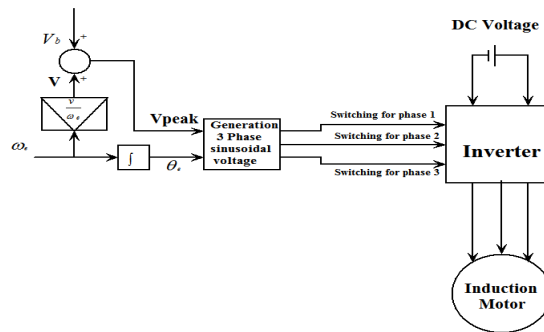

FIG. 2 OPEN LOOP SCALAR CONTROL

But when the dynamic performance is required the closed loop speed control can be applied as shown in Fig. 3. In this method of control, the motor speed is measured and compared to the reference speed. The error between the measured speed and reference speed is introduced to PI speed controller to deduce the slip frequency. The slip frequency is added to measure motor speed to get electrical frequency which is used to generate the reference voltage. With aid of reference voltages and electrical frequency, the three phase reference wave generates. These waveforms are compared to actual three phase measured as shown in Fig.3 and the output of these comparators are compared to the carrier wave to get the switching frequency of inverter.

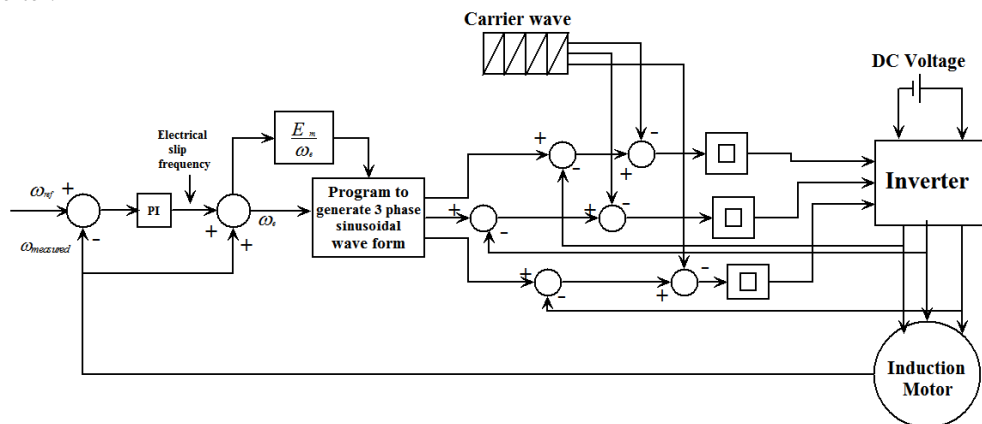

FIG. 3 CLOSED LOOP SCALAR CONTROL

IV. FIELD ORIENTED CONTROL

The field oriented control makes the induction motor emulates the separately excited DC motor. To understand this let's start with the principle torque equation

$$T_e = \alpha \psi_s \psi_r \sin \epsilon \cos \Gamma \tag{17}$$

Where ψ_s and ψ_r are stator and rotor flux linkages, ϵ and Γ are the space and time angles between stator and rotor flux linkages.

If it is applied on DC machine it is found that,

The space angle is equal to 90° and time angle is 0° because the field comes from DC field hence the torque equation becomes as the follows

$$T_e \propto \Psi_s \Psi_r \tag{18}$$

So the torque becomes maximum value. By applying this equation on induction motor, it found that, the space angle is smaller than 90°. Hence, to verify the same torque taken from DC, the rotor or stator flux must be increased, by such an increase in the stator current and hence it found that, the torque per ampere of DC is higher than the torque per ampere of induction motor. By applying the FOC it is found that, the torque problem is solved this is because the space angle between rotor flux and stator flux becomes 90°. Despite of FOC of induction motors has achieved a quick torque response, and has been applied in various industrial applications instead of DC motors. The FOC is very sensitive to flux estimation (magnitude and orientation) which is mainly effected by parameters variation. These parameters are affecting saturation, temperature, and skin effect. The consequence of any mismatch between the parameter values used in the controller and those in the motor makes the actual rotor flux position does not coincide with the position assumed by the controller. Any parameter mismatched in flux estimation will be detrimentally affect the torque response and then on the FOC dynamic performance. For these reasons, many researches study have been done on automated tuning of induction motor parameters. So this paper shows the effect of parameters variation on the performance characteristics of induction motor through applying the FOC comparing to SC.

The definition of field orientation implies that; the input current of the induction machine should be oriented. This can be verified by choosing reference frame speed (synchronous reference frame) which to be instantaneous speed of rotor flux linkage vector and locking such that the rotor flux is entirely in the d-axis i.e.

$$\Psi_{qr} = 0, \quad \rho \Psi_{qr} = 0 \tag{19}$$

$$\Psi_r = \Psi_{dr} \tag{20}$$

With this choice the d, q current and rotor flux appear as shown in Fig. 4.

By applying the constrain in eqs. No. ((19) -(20)) on rotor voltages equations in synchronous frame it found that,

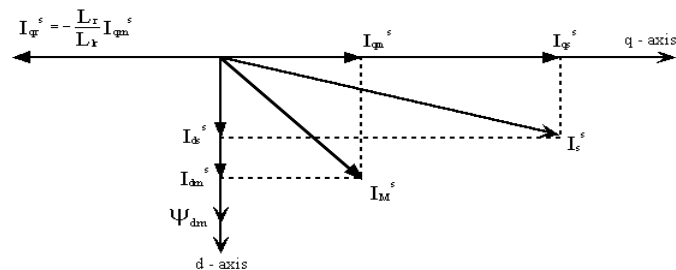

FIG. 4 d q CURRENTS WITH REFERENCE AXES ORIENTED TO THE ROTOR FLUX

$$I_{dr}^s = -\frac{\rho \Psi_{dr}^s}{R_r} \tag{21}$$

$$I_{qr}^s = -\frac{\omega_r \Psi_{dr}^s}{R_r} \tag{22}$$

$$I_{dm}^s = -\frac{\Psi_{dm}^s}{M} \tag{23}$$

$$I_{qm}^s = -\frac{L_{lr}}{M} I_{qr}^s \tag{24}$$

$$I_{dm}^s = \frac{\Psi_{dr}^s}{M} (1 + \tau_{cr} \rho) \tag{25}$$

where, $\tau_{\sigma r} = \frac{L_{lr}}{R_r}$

$$I_{qm}^s = \frac{\tau_{\sigma r} \omega_r}{M} \Psi_{dr}^s \tag{26}$$

$$I_{qs}^s - \omega_e \tau_{mr} I_{dm}^s = \left(\frac{L_r}{L_{lr}} + \tau_{mr} \rho \right) I_{qm}^s \tag{27}$$

Where, $\tau_{mr} = \frac{M}{R_c}$

$$I_{dr}^s = \frac{I_{dm}^s}{L_{lr}} (\Psi_{dr}^s - M) \tag{28}$$

$$I_{ds}^s + \omega_e \tau_{mr} I_{qm}^s + \frac{\Psi_{dr}^s}{L_{\sigma r}} = \left(\frac{L_r}{L_{lr}} + \tau_{mr} \rho \right) I_{dm}^s \tag{29}$$

$$T_e = \frac{3}{2} \frac{P}{2} M \Psi_{dr}^s I_{qm}^s \tag{30}$$

Fig. 5 shows Block diagram of induction motor dynamics with field oriented Control taking into account core loss resistance

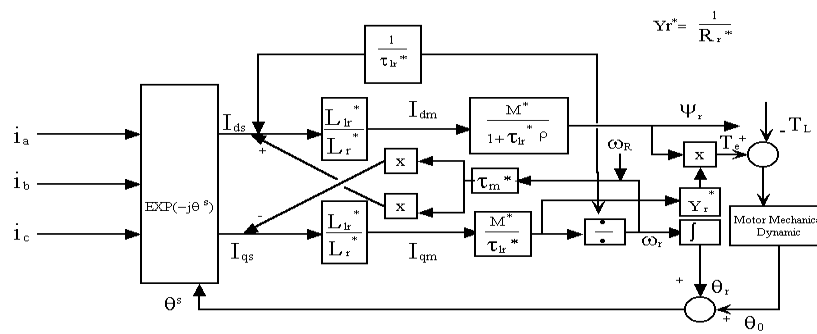

FIG. 5 BLOCK DIAGRAM OF INDUCTION MOTOR DYNAMICS WITH FIELD ORIENTED CONTROL TAKING INTO ACCOUNT CORE LOSS RESISTANCE

V. SIMULATION RESULTS

The effect of parameters variation at different frequencies on the performance characteristics of induction motor with FOC compared to SC is studied. This studying is concerned the starting and the full load in the two regions; (constant flux and field weakening). A very common way to set the flux reference is to use the flux level at the machine rated condition for speeds lower than base speed (constant torque region), and the flux reference is varied above the base speed i.e. the flux reference is inversely proportion to rotor speed, (field weakening region) [10].

5.1 Effect of the parameters variation of induction motor with FOC comparing to SC at starting

This shows the effect of parameters variation at starting, on the torque, input power, power loss and on the stator current with different frequencies. The parameters vary from 50% to 150%; from its value when it starts. Figs. 6 -8 show the effect of parameters variation on the starting torque with FOC compared to SC. The following can be concluded:

Higher variation in oriented starting torque comes from variation in rotor resistance; oriented starting torque is inversely proportional to rotor resistance. This occurs due to an increase in rotor resistance leads to a decrease of the torque current component which is directly proportional to the torque. In SC, the starting torque is directly proportional to rotor resistance although the decrease in the rotor current, because at starting, an increase in rotor resistance is more effect than the rotor current.

As the torque current component is directly proportional to the rotor reactance at constant frequency and the torque current component is directly proportional to the oriented torque, so it is clear that there is an increase –decrease connection between

rotor reactance and oriented torque but in SC, the increase of rotor reactance decreases the starting torque due to the decrease in rotor current i.e. the starting torque in SC is inversely proportional to rotor reactance.

Starting torque is inversely proportional to both of the stator resistance and stator reactance in both of SC and FOC because of the decrease in the stator current. This means that, applying the SC method shows the decrease of rotor current which has much effect on starting torque. Also in FOC by increasing stator resistance and stator reactance, the rotor and stator fluxes decrease causing the decrease in orientation torque.

The starting torque is directly proportional to magnetizing reactance in both of scalar and FOC at constant frequency. This means that in FOC the torque increases due to an increase in flux, while in SC the starting torque increases due to an increase in rotor current. Also the starting torque is directly proportional to core loss resistance in both SC and FOC.

The oriented torque is higher than traditional torque because in field orientation method, the rotor and stator fluxes are perpendicular so the torque is only directly proportional to them. In SC, the torque is directly proportional to rotor and stator fluxes and the sine angle between them. This angle is less than 90° so the production torque becomes less than the oriented torque with the same sine angle value.

At low frequencies, higher variation in starting torque comes from variation in stator resistance, the starting torque is inversely proportional to stator resistance in both of scalar and FOC this means that, the stator resistance will be significant at low frequencies.

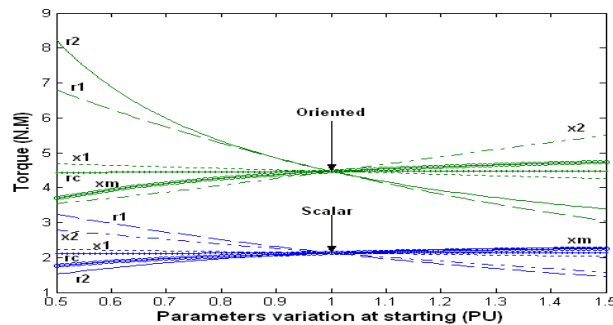

FIG. 6 VARIATION OF TORQUE WITH PARAMETERS AT 10 HZ

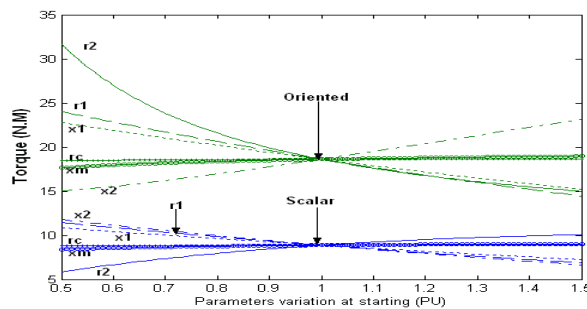

FIG. 7 VARIATION OF TORQUE WITH PARAMETERS AT 50 HZ

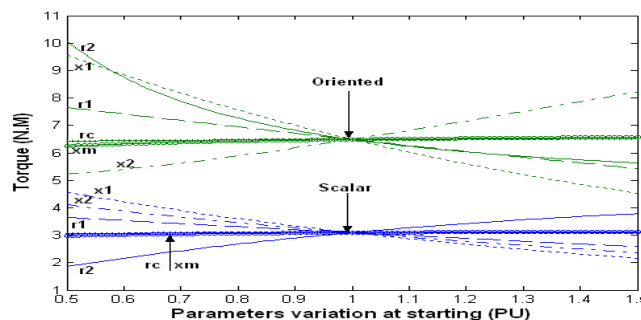

FIG. 8 VARIATION OF TORQUE WITH PARAMETERS AT 100 HZ

Figs. 9-11 represent the effect of parameters variation on the stator current at different frequencies with FOC and with SC, from which the following can be concluded:

In constant flux region, oriented stator current is inversely proportional to rotor resistance because the torque current component is inversely proportional to rotor resistance. In field weakening region, oriented stator current is inversely proportional to rotor resistance due to decrease in flux and torque current components. In SC, stator current is inversely proportional to rotor resistance in constant flux region and field weakening region. In constant flux region, oriented stator current is directly proportional to the rotor reactance while in SC, the stator current is inversely proportional to the rotor reactance. In both of field orientation and SC, stator current is inversely proportional to magnetizing reactance and core loss resistance. At low frequencies the higher variation in the stator current comes from the variation in stator resistance where at near from base frequency, the higher variation in the stator current comes from the variation in rotor resistance. In both of field orientation and SC, the stator current is inversely proportional to both of stator resistance and stator reactance. When the stator current of FOC is compared with the one of SC, it shows that, the stator current with field orientation is less than the stator current with SC. This is because the stator flux and rotor flux are perpendicular hence the torque per ampere in FOC is bigger than the torque per ampere in SC case.

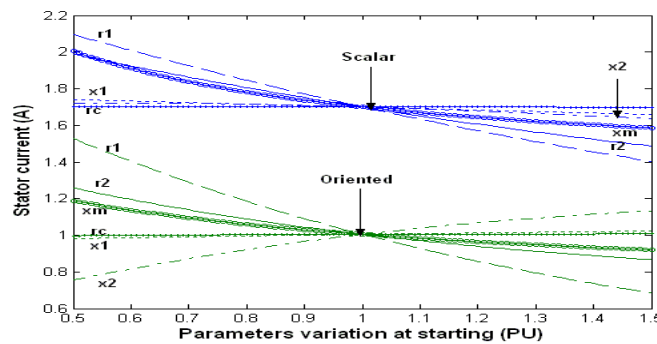

FIG. 9 VARIATION OF STATOR CURRENT WITH PARAMETERS AT 10 HZ

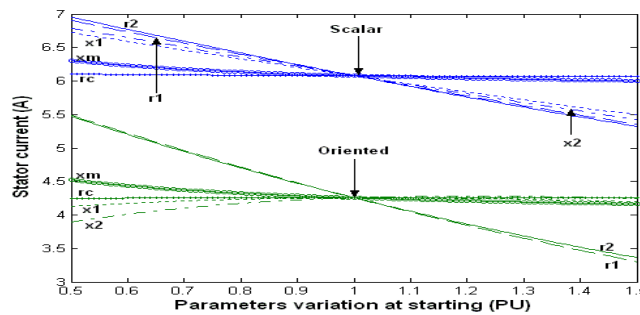

FIG. 10 VARIATION OF STATOR CURRENT WITH PARAMETERS AT 50 HZ

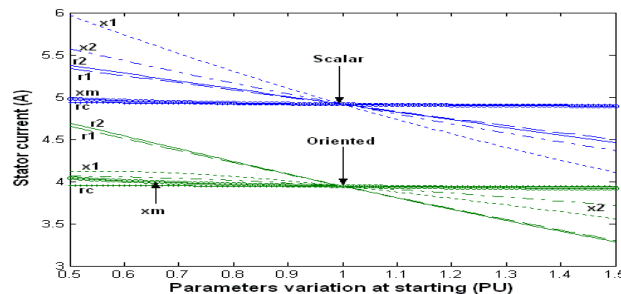

FIG. 11 VARIATION OF STATOR CURRENT WITH PARAMETERS AT 100 HZ

Figs. 12-14 show that, higher variation in input power comes from variation in rotor reactance and it is inversely proportional to rotor reactance due to the decrease in stator current. Input power is inversely proportional to stator reactance due to the decrease in stator current. Input power is inversely proportional to core loss resistance. Input power is inversely proportional to magnetizing reactance due to the decrease in stator current.

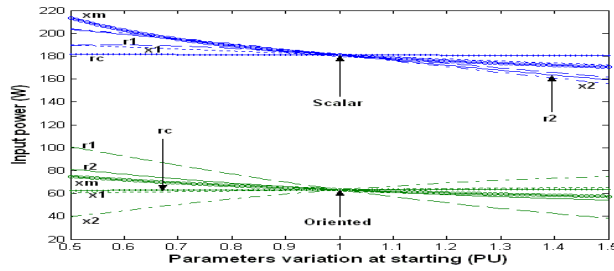

FIG. 12 VARIATION OF INPUT POWER WITH PARAMETERS AT 10 HZ

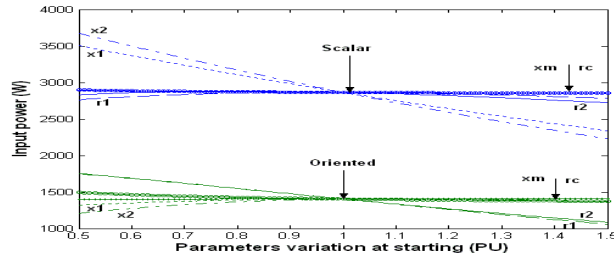

FIG. 13 VARIATION OF INPUT POWER WITH PARAMETERS AT 50 HZ

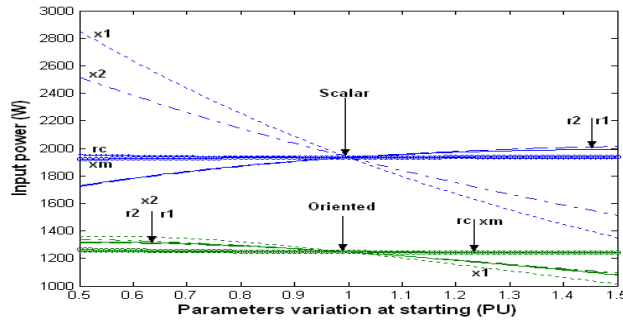

FIG. 14 VARIATION OF INPUT POWER WITH PARAMETERS AT 100 HZ

Input power is directly proportional to stator and rotor resistances due to the increase in power factor. At low frequency higher variation in input power comes from variation in stator resistance. By applying the field orientation, the input power of the motor becomes enhanced comparing with SC method. This is due to the decrease in the oriented stator current compared with the scalar stator current. when nearest from the base frequency and higher, the higher variation in input power comes from variation in rotor reactance.

From Figs. 15-17 it is found that,

As there is no out power, the input power is converted into power loss, and the parameters vary with power loss as the variation of its with input power.

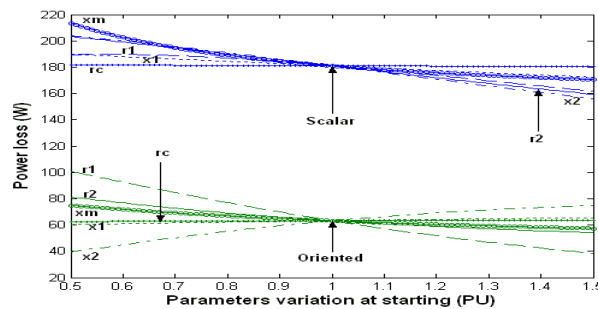

FIG. 15 VARIATION OF POWER LOSS WITH PARAMETERS AT 10 HZ

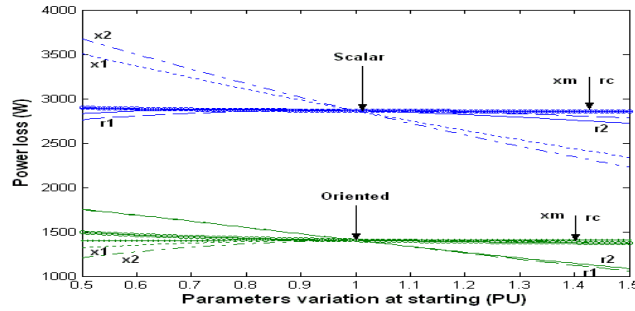

FIG. 16 VARIATION OF POWER LOSS WITH PARAMETERS AT 50 HZ

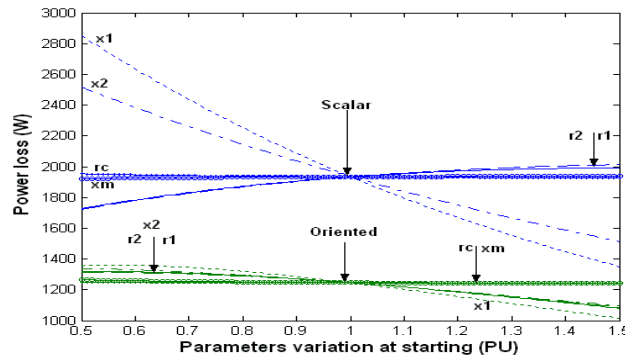

FIG. 17 VARIATION OF POWER LOSS WITH PARAMETERS AT 100 HZ

5.2 Effect of the parameters variation of induction motor with FOC comparing to SC at full load

The effect of parameters variation at full load, on the torque, input power, power loss, output power, efficiency and on the stator current with different frequencies when the parameters vary from 50% to 150%; from its value at full load are discussed here. Figs. 19-21 show the effect of parameters variation on the motor torque at different frequencies, with FOC compared to SC and can be concluded that:

Higher variation in oriented torque is caused by variation in rotor resistance. The oriented torque is inversely proportional to rotor resistance; any increase in rotor resistance leads to a decrease in the torque current component which is directly proportional to torque. In SC the torque is inversely proportional to rotor resistance. The oriented torque is inversely proportional to rotor reactance due to the effect of slip relation. In SC method, any increase in rotor reactance leads to a decrease in the torque due to a decrease in rotor current i.e. the torque in SC is inversely proportional to rotor reactance. The torque is inversely proportional to stator resistance and stator reactance in both of SC and FOC due to decrease in the stator current. This means that, in SC reducing rotor current has much effect on the torque. In FOC, the rotor flux and stator fluxes decrease leads to a decrease in orientation torque. The torque is directly proportional to magnetizing reactance in both of scalar and FOC at constant frequency. This means that in FOC, the torque increases due to an increase in flux, while in the SC, increasing in magnetizing reactance means that there is an increase in rotor current. The motor torque is directly proportional to core loss resistance in both of FOC and SC.

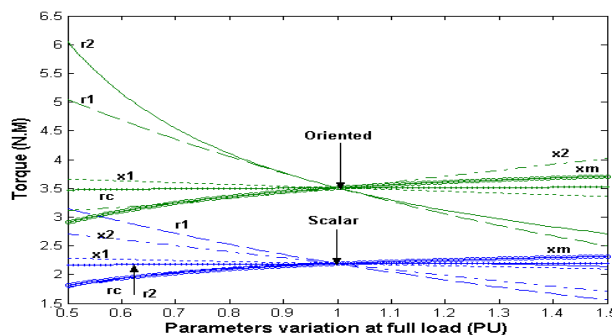

FIG. 19 VARIATION OF TORQUE WITH PARAMETERS AT 10 HZ

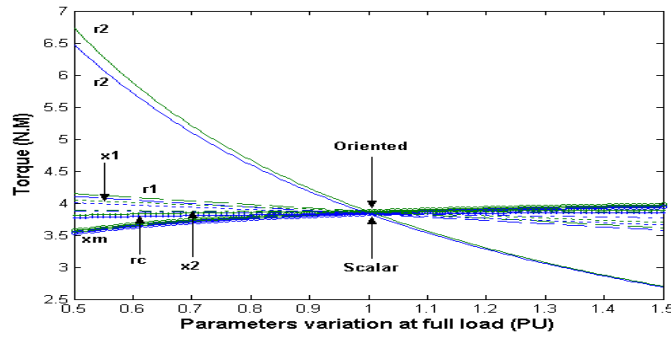

FIG. 20 VARIATION OF TORQUE WITH PARAMETERS AT 50 HZ

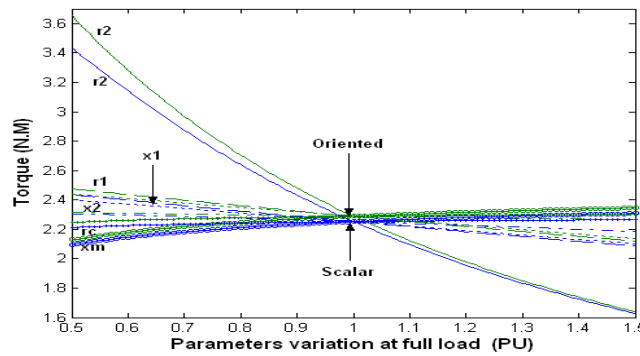

FIG. 21 VARIATION OF TORQUE WITH PARAMETERS AT 100 HZ

The oriented torque is bigger the scalar torque this is because the rotor and stator fluxes are perpendicular in one. The stator resistance will be significant at low frequencies so at low frequencies higher variation in the torque comes from variation in stator resistance in both of SC and FOC.

Figs. 22-24 show the effect of parameters variation on the stator current at different frequencies, with FOC comparing to SC from which can be concluded:

At higher frequency, higher variation in stator current resulted from variation of rotor resistance with FOC and SC. In both types of control (field oriented and SC) the stator current is inversely proportional to rotor resistance. At low frequencies, the higher variation in the stator current comes from variation in stator resistance in both of SC and FOC. When the FOC is applied, the stator current is directly proportional to rotor reactance due to an increase in torque current component also, in SC the same effect is occurred. Stator current is inversely proportional to magnetizing reactance, core loss resistance, stator resistance and stator reactance in both of the FOC and the SC. When the stator current of the FOC is compared with SC, the stator current of the FOC is less than stator current of the SC because stator and rotor fluxes are perpendicular. But the same angle of the SC is less than 90° so the torque per ampere of the FOC is higher than the torque per ampere in the SC case.

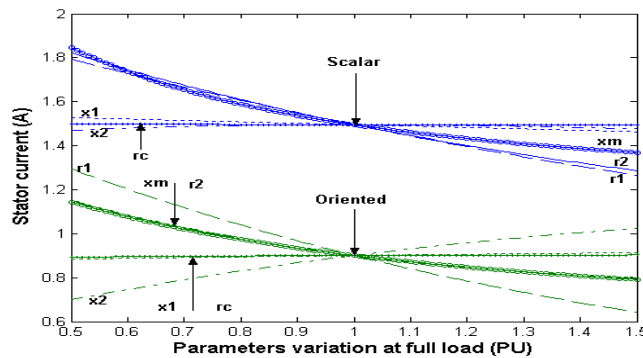

FIG. 22 VARIATION OF STATOR CURRENT WITH PARAMETERS AT 10 HZ

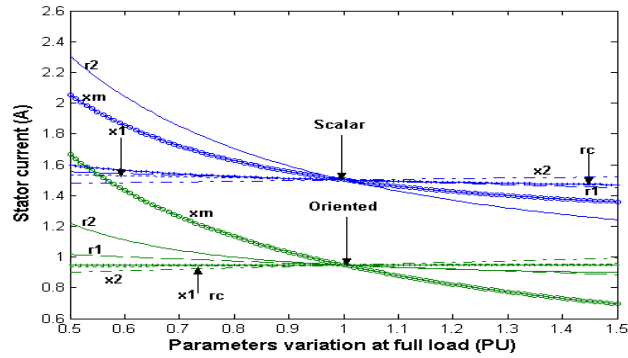

FIG. 23 VARIATION OF STATOR CURRENT WITH PARAMETERS AT 50 HZ

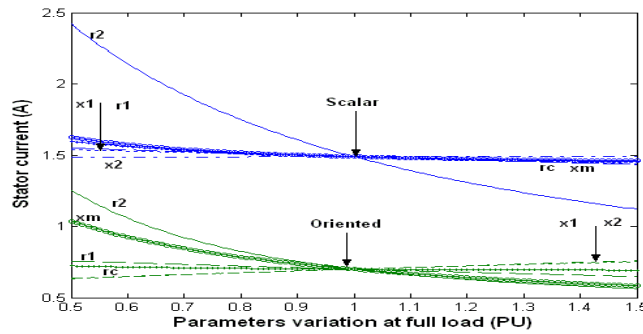

FIG. 24 VARIATION OF STATOR CURRENT WITH PARAMETERS AT 100 HZ

From Figs. 25-27 it found that, Input power is inversely proportional to stator reactance due to the decrease in stator current. Input power is inversely proportional to magnetizing reactance, due to the decrease in stator current. Input power is inversely proportional to stator resistance, due to the decrease in stator current.

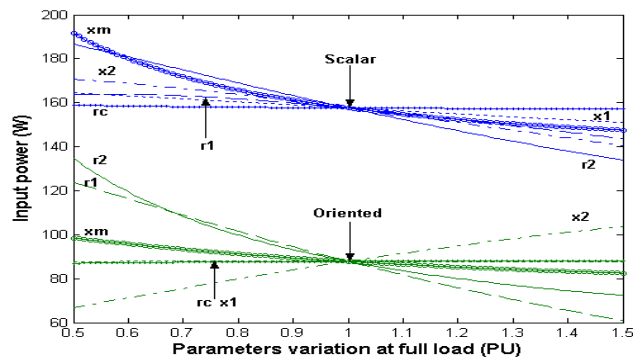

FIG. 25 VARIATION OF INPUT POWER WITH PARAMETERS AT 10 HZ

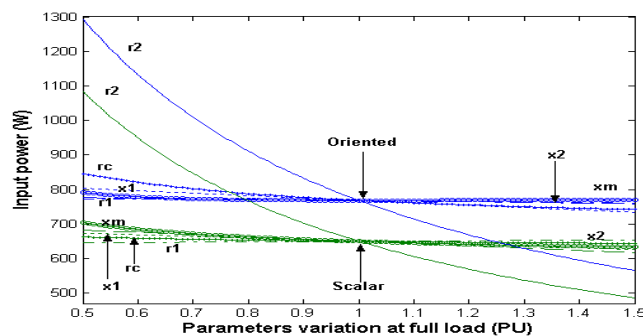

FIG. 26 VARIATION OF INPUT POWER WITH PARAMETERS AT 50 HZ

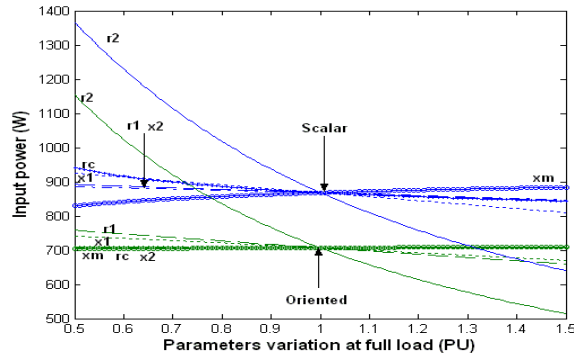

FIG. 27 VARIATION OF INPUT POWER WITH PARAMETERS AT 100 HZ

Higher variation in input power comes from variation in rotor resistance; it is inversely proportional to rotor resistance. Input power with FOC is less than it if comparing with SC method. This is due to the decrease in the oriented stator current when compared to the scalar stator current.

Figs. 28-30 represent the effect of parameters variation on the output power at different frequencies where from these Figs it is found that, it is identical to the variation of the parameters with motor torque this is because the motor operates at rated speed.

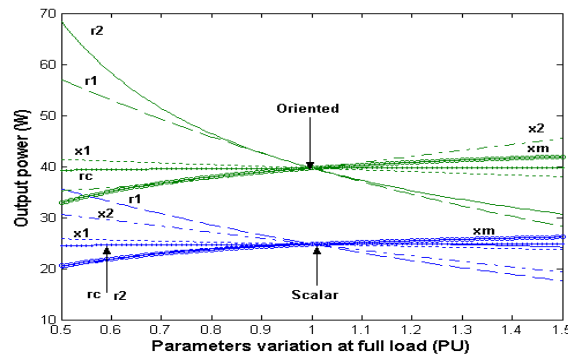

FIG. 28 VARIATION OF OUTPUT POWER WITH PARAMETERS AT 10 HZ

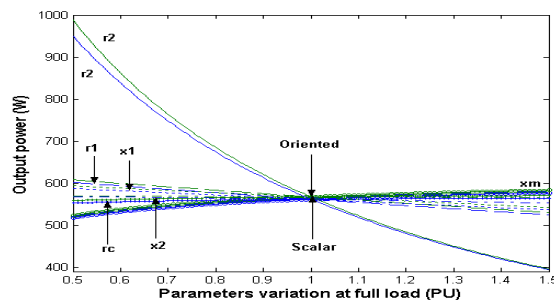

FIG. 29 VARIATION OF OUTPUT POWER WITH PARAMETERS AT 50 HZ

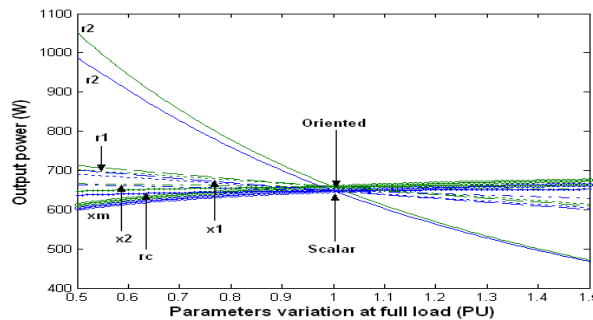

FIG. 30 VARIATION OF OUTPUT POWER WITH PARAMETERS AT 100 HZ

Figs. 31-33 show the effect of the parameters variation on the power loss at different frequencies with FOC comparing to SC which from it can be concluded:

In both of scalar and FOC, higher variation in power loss comes from variation in rotor resistance which is inversely proportional to rotor resistance. This occurs because the decrease in stator and rotor currents leads to a decrease their, in both of constant flux and field weakening regions. At the control methods under study, power loss is inversely proportional to stator reactance; because the decrease in stator current leads to a decrease in stator and rotor copper losses in both of constant flux region and field weakening region. With two control methods under discussion, power loss is inversely proportional to magnetizing reactance, because the decrease in stator current leads to a decrease in power loss in both of constant flux and field weakening regions.

In the two control methods under discussion, power loss is approximately directly proportional to rotor reactance in constant flux and in field weakening regions, due to an increase in the current. In the two control methods under study, power loss is inversely proportional to core loss resistance, because the decrease in stator current leads to a decrease in the copper loss in both of constant flux region and field weakening region. Power loss is directly proportional to stator resistance, because an increase in stator resistance is more effective than a decrease in stator current in both of field weakening region and constant flux region. Power loss of the motor with FOC is less than it if comparing with SC method. This is due to the decrease in the oriented stator current when compared with the scalar stator current. At low frequency higher variation in power loss comes from variation in stator resistance.

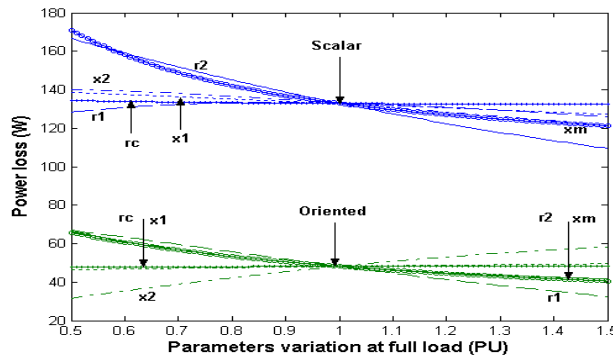

FIG. 31 VARIATION OF POWER LOSS WITH PARAMETERS AT 10 HZ

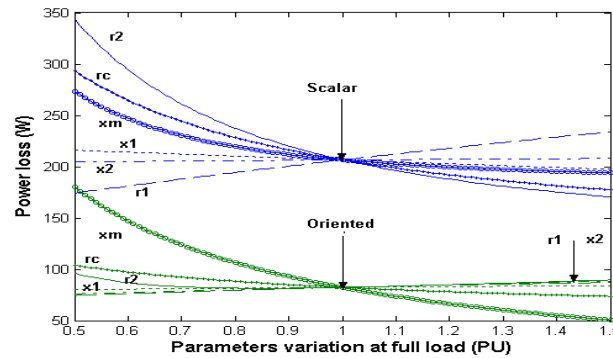

FIG. 32 VARIATION OF POWER LOSS WITH PARAMETERS AT 50 HZ

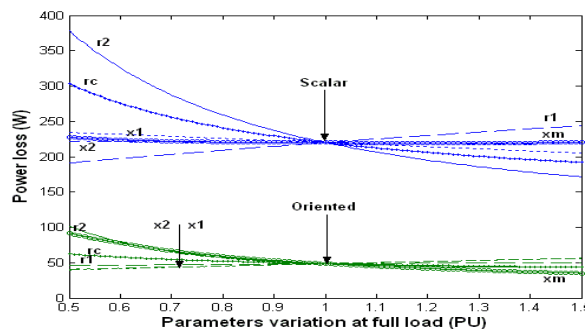

FIG. 33 VARIATION OF POWER LOSS WITH PARAMETERS AT 100 HZ

Figs. 34-36 represent the effect of parameters variation on the efficiency at different frequencies, with FOC compared to SC from which the following can be concluded:

The efficiency is directly proportional to the frequency. The FOC efficiency is higher than the SC efficiency. At low frequency of the SC case and in FOC, the efficiency of higher variation resulting variation in stator resistance which is inversely proportional to stator resistance. Higher variation in efficiency comes from variation in core loss resistance in both of field oriented and SC above the base frequency.

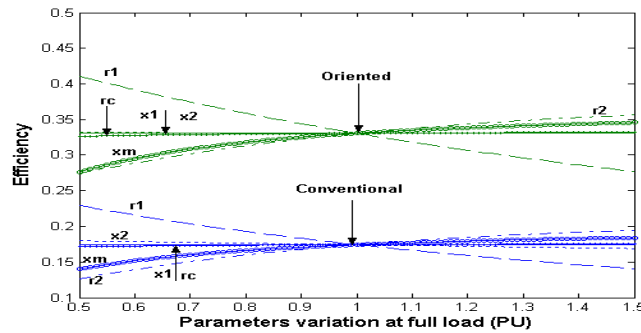

FIG. 34 VARIATION OF EFFICIENCY WITH PARAMETERS AT 10 HZ

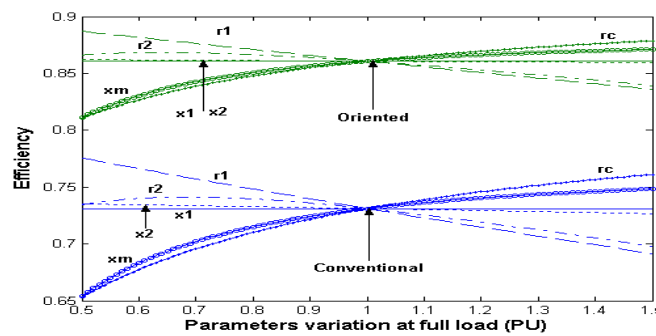

FIG. 35 VARIATION OF EFFICIENCY WITH PARAMETERS AT 50 HZ

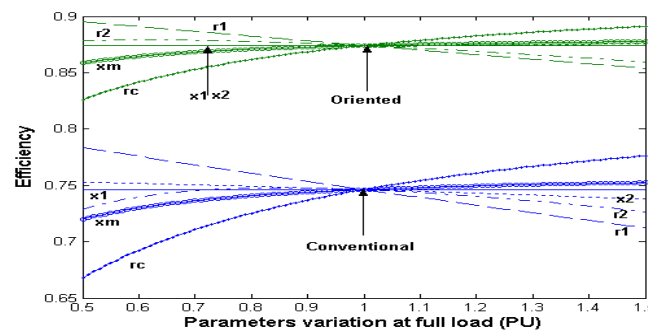

FIG. 36 VARIATION OF EFFICIENCY WITH PARAMETERS AT 100 HZ

The efficiency of the two control methods is directly proportional to core loss resistance and higher variation in efficiency arises from variation in core loss resistance in both of field oriented and SC where efficiency is directly proportional to magnetizing reactance. There is no effect of stator reactance on efficiency. The efficiency of both FOC and SC is inversely proportional to rotor reactance.

VI. CONCLUSION

From the effect of the parameters variation on the performance characteristics of induction motor with FOC at starting, it is concluded that:

FOC starting torque is the higher if it is compared with the scalar control starting torque. Higher variation in orientation torque comes from variation in rotor resistance. Oriented torque is directly proportional to rotor reactance where scalar torque is inversely proportional to its. FOC power loss is the smaller if it is compared with the scalar control power loss. FOC input

power is the smaller if it is compared with the scalar control input power. The overall performance of induction motor becomes improvement with FOC if it is compared to SC.

The effect of parameters variation on the performance characteristics of induction motor with FOC compared to SC at full load is concluded as;

FOC torque is the higher if it is compared with the scalar control torque. Higher variation in oriented torque and scalar torque are caused by variation in rotor resistance. The oriented torque is inversely proportional to rotor resistance. The oriented torque and scalar torque are inversely proportional to rotor reactance. Higher variation in power loss comes from variation in rotor resistance which is inversely proportional to rotor resistance. FOC efficiency is the higher if it is compared with the scalar control efficiency. The overall performance of induction motor becomes improvement with FOC if it is compared to SC.

LIST OF SYMBOLS

I_{dc}, I_{qc} : d,q axes core loss currents, I_{dm}, I_{qm} : d,q axes magnetizing currents, I_{ds}, I_{qs} : d,q axes stator currents, I_{dr}, I_{qr} : d,q axes rotor current, L_{ls}, L_{lr} : Stator , rotor leakage phase inductances, L_s, L_r : Stator , rotor phase self-inductances, M : Magnetizing phase inductance, P : Number of poles, R_s, R_r : Stator , rotor phase resistance, R_c : Core loss phase resistance, s : Superscripts means synchronous reference frame, T_e : Electromagnetic torque, T_L : Load torque, V_{ds}, V_{qs} : d,q axes stator voltages, ρ : Derivative time, ψ_s, ψ_r : Stator , rotor flux angles, ψ_{ds}, ψ_{qs} : d,q axes of stator fluxes, ψ_{dr}, ψ_{qr} : d,q axes of rotor fluxes, ψ_{dm}, ψ_{qm} : d,q axes of magnetizing fluxes, ω_e : Excitation frequency of stator current and ω_r : Frequency of rotor current

Motor parameters: Line to line voltages=380V, Full load current=1.47A, Rotor speed=1400 R.P.M, Pole pairs=2, Full load torque=3.82 N.m, Power factor=0.8, Stator resistance= 13 Ohm, Stator reactance=10.5 Ohm, core loss resistance= 1450 Ohm, Magnetizing reactance=231 Ohm, Rotor resistance=2.25S+12.35 Ohm, Rotor reactance=-3.694S+19.2643 Ohm, Output power=0.75 hp, $T_s/T_f=2.33$, $T_{max}/T_f=2.62$ $I_s/I_f=4.22$ and Efficiency=0.72

REFERENCES

- [1] M.D. Murphy, F.G Turnball Power electronic control of A.C motors, Pergamon press, 1986.
- [2] Bose B.K: Power Electronics and Variable Frequency Drives, IEEE Press, 1997.
- [3] W.B Rosink, "Analogue control system for A.C motor with PWM variable speed," in proceedings of Electronic Components and Application, vol. 3, no. 1, pp. 6-15, May 1980.
- [4] B.G. Starr, J.C.F. Van Loon, "LSI circuit for AC motor speed control," in proceedings of Electronic Components and Application, vol. 2, no. 4, pp. 219-229, August 1980.
- [5] F. Blaschke, "The Principle of Field Orientation Applied to the New Transvector Closed-Loop Control System for Rotating Field Machines," Siemens-Rev., vol. 39, pp. 217-220, 1972.
- [6] W. Leonhard, "Field Orientation for Controlling AC Machines Principle and Application," A tutorial, IEE conf. on power electronic variable speed drives conf. pub. No. 291, London, pp. 277-282,1988.
- [7] R.Krishnan, F.C. Doran, "Study of parameter sensitivity in high performance and inverter fed Induction motor drive system," IEEE Transactions on Industry Applications. Vol. IA-23 No.4, pp.623-635, 1986.
- [8] R. Krishnan, A.S. Bhardawaj, "A Review of Parameter sensitivity and adaptation in Industrial vector controlled Induction motor drive system," IEEE Trans. on Power Electronics, Vol.6, No.4, 1991 pp.219-225, 1991.
- [9] Hamid.A. Toliyat, Emil Levi, Mona Raina, "A Review of RFO Induction motor parameter Estimation Technique," IEEE Transaction on Energy Conversions, Vol.18, No.2, pp 356-365, 2003.
- [10] Hamdy Mohamed Soliman, "Studying the Steady State Performance Characteristics of Induction Motor with Field Oriented Control Comparing to Scalar Control," EJERS, European Journal of Engineering Research and Science, Vol. 1, No. 2, pp 18-25, 2016.



Dr. Hamdy Mohamed Soliman was born in Cairo-Egypt on 26 December 1970, He received B. Sc. in Electrical Power and Machine Engineering from Helwan University in 1993, master of science in area of electrical machine and drive systems. Master of science is from Benha University and PhD Degree from Cairo University, Giza, Egypt in 2016. The area of PhD is electrical machines and drives. He is a director of development and research of train units in Egyptian company metro. His current research interests include power electronics, motor controls and drive systems.